

Master Lock®

L'INNOVATION
LA CLÉ DE LA SÉCURITÉ

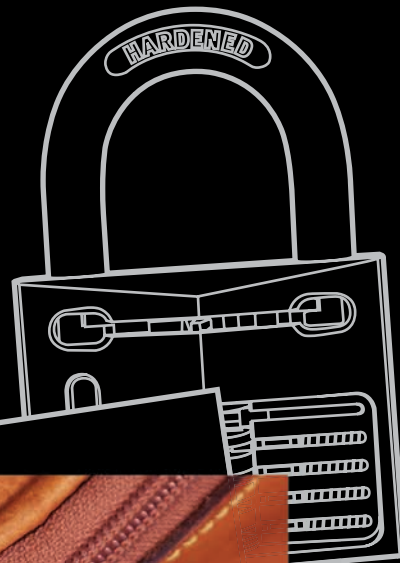

INNOVATION
THE KEY TO SECURITY

COMMENT UTILISER CE CATALOGUE HOW TO USE THIS CATALOG

Ce catalogue est conçu pour vous aider à choisir le cadenas adapté à vos besoins. Afin de faciliter votre choix, toutes les caractéristiques produit sont clairement identifiées.

This catalog is designed to help you choose the right padlock for your application. All products specifications are clearly identified in this catalog to help your selection.

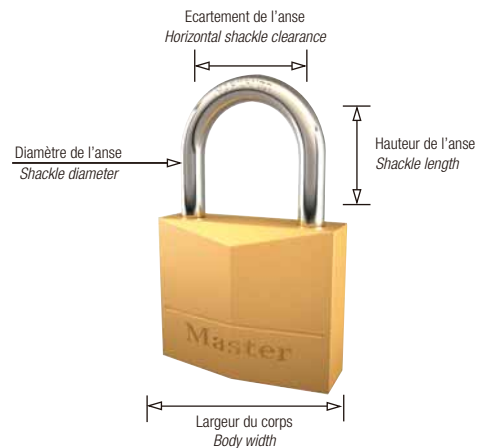

UNE CLASSIFICATION UNIQUE POUR GUIDER LE CHOIX DES CONSOMMATEURS UNDERSTANDING OUR SECURITY SCALE

Sur l'ensemble des produits MASTER LOCK®, **une échelle de sécurité graduée de 1 à 10** indique le niveau de sécurité de chaque produit. Cette classification permet au consommateur de choisir son produit en fonction de la protection recherchée.

Ex. : un cadenas classé 2 ou 3 est préconisé pour la protection de bagages, le produit de niveau 5 sera plutôt recommandé pour des applications courantes (vestiaires, portes de cave...). Les niveaux 8 ou supérieurs indiquent qu'il s'agit de cadenas haute sécurité, adaptés à toutes les utilisations type portes de garage, portails, rideaux de magasin, barrières d'usine, dos de camion, remises, bateaux...

Master Lock® products all include a scale from 1 to 10, which indicates the security level of each product. This help customers to choose what they need.

E.g. a padlock with a scale of 2 or 3 is recommended for luggage, whilst a level 5 is generally used for lockers and tool boxes. A level 8 or higher offers high security for a range of uses including on garages, gates, vans, sheds, boats and more.



Echelle de sécurité
Security level

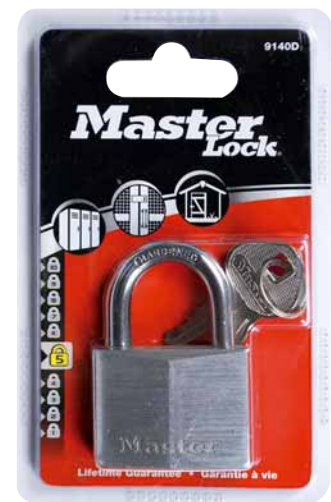

Emballage carte et blister :
Blister card packaging:

19 langues : anglais, français, allemand, néerlandais, espagnol, italien, portugais, grec, norvégien, danois, suédois, finlandais, polonais, hongrois, roumain, tchèque, turque, russe et japonais.

19 languages: English, French, German, Dutch, Spanish, Italian, Portuguese, Greek, Norwegian, Danish, Swedish, Finish, Polish, Hungarian, Romanian, Czech, Turkish, Russian and Japanese.

PICTOGRAMMES DES EMBALLAGES - USAGES SUGGÉRÉS CONSUMER DRIVEN ICON PACKAGING



SOMMAIRE

TABLE OF CONTENTS



SECURITÉ GÉNÉRALE	4	GENERAL SECURITY
LAITON MASSIF - ANSE ACIER	6	SOLID BRASS BODY - STEEL SHACKLE
LAITON MASSIF - HAUTE SÉCURITÉ	8	SOLID BRASS BODY - HIGH SECURITY
LAITON MASSIF ANSE LAITON	9	SOLID BRASS BODY - BRASS SHACKLE
LAITON MASSIF - ANSE PROTÉGÉE	9	SOLID BRASS BODY - SHROUDED SHACKLE
LAITON MASSIF - RECTANGULAIRE	9	SOLID BRASS BODY - RECTANGULAR
ANSE AMOVIBLE	10	REMOVABLE SHACKLE
ACIER LAMINÉ	11	LAMINATED STEEL
ALUMINIUM	12	ALUMINIUM
PROTECTION VINYLE NOIRE	14	BLACK VINYL COVER
PROTECTION VINYLE COULEURS	16	COLOUR VINYL COVER
FUSION™	18	FUSION™
CADENAS CERTIFIÉS TSA	20	TSA-ACCEPTED PADLOCKS
COMBINAISON PROGRAMMABLE	22	RESETTABLE COMBINATION
ONE®	28	ONE®
COMBINAISON "COFFRE-FORT"	29	"SAFETY BOX" COMBINATION
MOUSQUETONS	30	CARABINERS
SECURITÉ TOUTES INTEMPÉRIES	33	WEATHER TOUGH® SECURITY
TITANIUM™	34	TITANIUM™
CADENAS MARINE	36	MARINE PADLOCKS
EXCELL®	38	EXCELL®
HAUTE SÉCURITÉ	41	HIGH SECURITY
ANSE HEXAGONALE	42	HEXAGONAL SHACKLE
CADENAS BLINDÉS	43	ARMOURED PADLOCKS
COMBINAISON HAUTE SÉCURITÉ	44	HIGH SECURITY COMBINATION
ACIER LAMINÉ & MASSIF	45	LAMINATED & SOLID STEEL
EXCELL®- ACIER LAMINÉ	46	EXCELL®- LAMINATED STEEL
EXCELL®- ACIER MASSIF	48	EXCELL®- SOLID STEEL
EXCELL®- FINITION LAITON	49	EXCELL®- BRASS FINISH
PRO-SERIES™ TOUTES INTEMPÉRIES	50	PRO-SERIES™ WEATHER TOUGH®
PORTE-CADENAS	52	HASPS
PORTE-CADENAS - UTILISATIONS INTÉRIEURES	54	HASPS - INDOOR USE
PORTE-CADENAS - UTILISATIONS EXTÉRIEURES	56	HASPS - OUTDOOR USE
PORTE-CADENAS - UTILISATIONS SPÉCIFIQUES	58	HASPS - SPECIFIC USE
ÉBAUCHES DE CLÉS	59	KEY BLANKS
MERCHANDISING	60	MERCHANDISING
INDEX	62	INDEX







SECURITÉ GÉNÉRALE

GENERAL SECURITY

Master Lock® crée des cadenas depuis 1921. Il en existe de toutes tailles, avec des anses hautes, des anses protégées, avec fermeture à clés, à combinaison... Ils se déclinent à l'infini pour répondre à tous types d'usages et d'applications. La force et l'audace de Master Lock® sont d'allier innovation, sécurité et design et d'apporter de la couleur pour personnaliser son cadenas et le rendre unique.

Découvrez au fil de ces pages ce qui fait l'authenticité et la singularité de Master Lock®.

Tous les cadenas Master Lock® bénéficient d'une **garantie à vie limitée**.

MasterLock® has manufactured padlocks since 1921. The range includes an extensive range of body sizes, shackles lengths, shrouded shackles, and keyed or combination locking... There is a lock for every need and application. Master Lock®'s strength is to combine innovation with security and design, bringing together colour and shape to create a secure but distinctive padlock.

This brochure demonstrates how Master Lock® has combined these features to make MasterLock® the most innovative range of padlocks available.

*In addition, all MasterLock® padlocks have a **limited lifetime guarantee**.*

Indémodable avec ses couleurs chaudes et dorées, il s'agit du cadenas le plus vendu sur le marché européen. La profondeur de gamme Master Lock® en cadenas laiton permet de proposer un cadenas spécifique pour tous types d'usages. Comme tous les cadenas Master Lock®, ils sont garantis à vie.

De forme diamant, ils se déclinent dans toutes les tailles : du petit cadenas bagage, en passant par la taille intermédiaire (40 mm) pour protéger une cave, un placard ou un vestiaire, jusqu'au 70 mm, plus adapté pour un portail ou une remise.

L'emballage en blister double coque avec pictogrammes suggérant des applications rend l'offre en magasin attrayante et apporte de la clarté au linéaire.



150

A classic, these are the largest volume of sales in the European market. The depth of the Master Lock® brass range means there is a specific padlock for any application. As with all Master Lock® padlocks, there is a lifetime guarantee.

Diamond shaped, they are available in an extensive range of sizes depending on the application: from the small stylish luggage locks, up to 70 mm for heavy duty applications. The larger sizes are ideal for securing gates, workshops and sheds.

The brightly coloured clamshell packaging with application icons creates a clear and attractive planogram.

Cadenas laiton massif anse laiton/Solid brass padlocks brass shackle

Référence/Reference	120EURD	120EURT	120EURQNOP	130EURD	130EURT
<i>Largeur du corps/Body width</i>	20 mm	20 mm	20 mm	30 mm	30 mm
<i>Diamètre de l'anse/Shackle diameter</i>	4 mm	4 mm	4 mm	5 mm	5 mm
<i>Hauteur d'anse/Shackle length</i>	11 mm	11 mm	11 mm	16 mm	16 mm
<i>Ecartement de l'anse/Horiz. shackle clearance</i>	10 mm	10 mm	10 mm	14 mm	14 mm
Corps/Body					
<i>Laiton/Brass</i>	•	•	•	•	•
Anse/Shackle					
<i>Acier std./Std. steel</i>	•	•	•		
<i>Acier cémenté/Hardened steel</i>				•	•
<i>Simple verrouillage/Simple locking</i>	•	•	•		
<i>Double verrouillage/Double locking</i>				•	•
Cylindre/Cylinder					
<i>Nombre de goupilles/Number of pins</i>	3	3	3	4	4
<i>Nombre de clés /Number of keys</i>	2	2	4	2	2
Cadenas s'ouvrant/Keyed alike padlocks					
<i>Une même clé ouvre tous les cadenas/Same key opens all padlocks</i>		•	•		•
<i>Nombre de cadenas/Number of padlocks</i>		2	4		2

ANSE ACIER STEEL SHACKLE

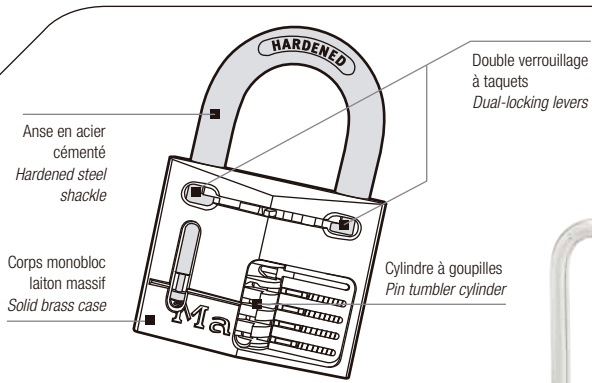

Corps monobloc laiton massif.
 Anse acier cémenté double verrouillage.
 Cylindre à goupilles.

Solid brass case.
 Double locking hardened steel shackle.
 Pin tumbler cylinder.



130EURQNOP	130EURDLJ	140EURD	140EURT	140EURQNOP	140EURSIX	140EURDLF	140EURDLH	150EURD	150EURT	150EURQNOP	150EURDLJ	160EURD	170EURD
30 mm	30 mm	40 mm	40 mm	40 mm	40 mm	40 mm	40 mm	50 mm	50 mm	50 mm	50 mm	60 mm	70 mm
5 mm	5 mm	6 mm	6 mm	6 mm	6 mm	6 mm	6 mm	7 mm	7 mm	7 mm	7 mm	9 mm	11 mm
16 mm	64 mm	22 mm	22 mm	22 mm	22 mm	38 mm	51 mm	25 mm	25 mm	25 mm	64 mm	29 mm	36 mm
14 mm	14 mm	21 mm	21 mm	21 mm	21 mm	21 mm	21 mm	25 mm	25 mm	25 mm	25 mm	32 mm	39 mm
•	•	•	•	•	•	•	•	•	•	•	•	•	•
•	•	•	•	•	•	•	•	•	•	•	•	•	•
•	•	•	•	•	•	•	•	•	•	•	•	•	•
4	4	4	4	4	4	4	4	5	5	5	5	5	6
4	2	2	2	4	6	2	2	2	2	4	2	2	2
•	•	•	•	•	•	•	•	•	•	•	•	•	•
4			2	4	6				2	4			

La série de cadenas Master Lock® avec corps en laiton massif très épais offre une protection accrue aux attaques extérieures :

- anse en acier cémenté avec double-verrouillage pour une forte résistance au coupe-boulons et à l'arrachage,
- corps monobloc en laiton massif pour une meilleure résistance à la rouille,
- cylindre de sécurité avec clé réversible pour une excellente résistance au crochetage.

Les multiples tailles de cadenas et hauteurs d'anse de la gamme permettent d'offrir un cadenas adapté à tout type d'usage : d'une porte de vestiaires ou de cave (30 et 40 mm) jusqu'à une porte de garage ou un rideau de magasin (70 mm).

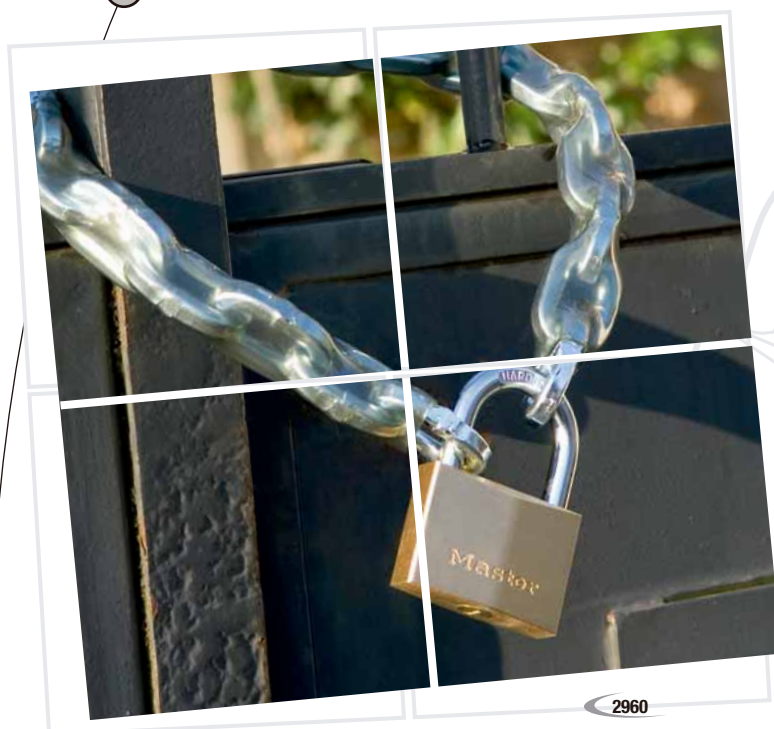

SÉCURITÉ RENFORCÉE REINFORCED SECURITY



2930

2940



2940LH



2950



2950LJ



2960

The Master Lock® padlock series, with a thick solid brass body, provides an increased level of protection to attacks and includes:

- a hardened steel shackle that provides strong resistance to bolt cutters
- dual locking levers that give the shackle additional pull strength
- a single piece brass body that gives the padlock better resistance to rust
- a security cylinder with reversible key for excellent resistance to picking.

The range comes in a variety of padlock sizes and shackle heights, making them suitable for a wide range of uses, from a locker or basement unit (30 and 40 mm) to a garage or shed (70 mm).

Cadenas laiton massif anse acier cémenté/Solid brass padlocks hardened steel shackle

Référence/Reference	2930EURD	2940EURD	2940EURDLH	2950EURD	2950EURDLJ	2960EURD
Largeur du corps/Body width	30 mm	40 mm	40 mm	50 mm	50 mm	60 mm
Diamètre de l'anse/Shackle diameter	5 mm	6 mm	6 mm	8 mm	8 mm	9 mm
Hauteur d'anse/Shackle length	17 mm	22 mm	51 mm	30 mm	64 mm	36 mm
Ecartement de l'anse/Horiz. shackle clearance	16 mm	22 mm	22 mm	27 mm	27 mm	33 mm
Corps/Body						
Laiton/Brass	•	•	•	•	•	•
Anse/Shackle						
Acier cémenté/Hardened steel	•	•	•	•	•	•
Double verrouillage/Double locking	•	•	•	•	•	•
Cylindre/Cylinder						
Nombre de goupilles/Number of pins	4	5	5	6	6	6
Nombre de clés/Number of keys	4	4	4	4	4	4

ANSE LAITON BRASS SHACKLE



645

Corps monobloc laiton massif. *Solid brass body.*
Anse laiton. *Brass shackle.*
Cylindre à goupilles. *Pin tumbler cylinder.*
Résiste à la corrosion. *Corrosion resistant.*

Cadenas laiton massif anse laiton/Solid brass padlocks brass shackle							
Référence/Reference	115EURD	3115EURD	635EURD	635EURT	645EURD	645EURTRI	655EURD
Largeur du corps/Body width	15 mm	15 mm	35 mm	35 mm	45 mm	45 mm	55 mm
Diamètre de l'anse/Shackle diameter	3 mm	3 mm	4 mm	4 mm	6 mm	6 mm	7 mm
Hauteur d'anse/Shackle length	10 mm	10+10+20 mm	16 mm	16+38 mm	24 mm	24 mm	24 mm
Ecartement de l'anse/Horiz. shackle clearance	8 mm	8 mm	19 mm	19 mm	24 mm	24 mm	25 mm
Corps/Body							
Laiton/Brass	•	•	•	•	•	•	•
Anse/Shackle							
Laiton massif/Solid brass	•	•	•	•	•	•	•
Simple verrouillage/Simple locking	•	•					
Double verrouillage/Double locking			•	•	•	•	•
Cylindre/Cylinder							
Nombre de goupilles/Number of pins	3	3	4	4	4	4	4
Nombre de clés/Number of keys	2	3	2	4	2	2	2
Cadenas s'ouvrant/Keyed alike padlocks <i>Une même clé ouvre tous les cadenas/Same key opens all padlocks</i>				•		•	
Nombre de cadenas/Number of padlocks		3		2		3	

ANSE PROTÉGÉE SHROUDED SHACKLE



2240

Corps monobloc laiton massif.
Anse acier cémenté.
Double verrouillage à billes.
Protection d'anse.
Cylindre à goupilles.
Retenue de clé.

Solid brass case.
Hardened steel shackle.
Double ball bearing locking.
Shrouded shackle.
Pin tumbler cylinder.
Key retaining.

RECTANGULAIRE RECTANGULAR



607

Corps monobloc laiton massif. *Solid brass body.*
Anse horizontale sautante en acier cémenté. *Horizontal hardened steel shackle.*
Cylindre à goupilles. *Pin tumbler cylinder.*
Ce verrouillage horizontal de sécurité rend l'anse inaccessible. *Its horizontal security locking makes the shackle difficult to attack.*

Cadenas laiton massif anse acier cémenté/Solid brass padlocks hardened steel shackle					
Référence/Reference	2240EURD	2250EURD	606EURD	607EURD	608EURD
Largeur du corps/Body width	40 mm	50 mm	63 mm	76 mm	85 mm
Diamètre de l'anse/Shackle diameter	6 mm	9 mm	10 mm	11 mm	12 mm
Hauteur d'anse/Shackle length	20 mm	20 mm	13 mm	14 mm	16 mm
Ecartement de l'anse/Horiz. shackle clearance	14 mm	19 mm	18 mm	23 mm	29 mm
Corps/Body					
Laiton/Brass	•	•	•	•	•
Anse/Shackle					
Acier cémenté/Hardened steel	•	•	•	•	•
Double verrouillage/Double locking	•	•	•	•	•
Anse protégée/Shrouded shackle	•	•			
Cylindre/Cylinder					
Nombre de goupilles/Number of pins	5	5	5	5	5
Retenue de clé/Key retaining	•	•			
Nombre de clés/Number of keys	2	2	2	2	2

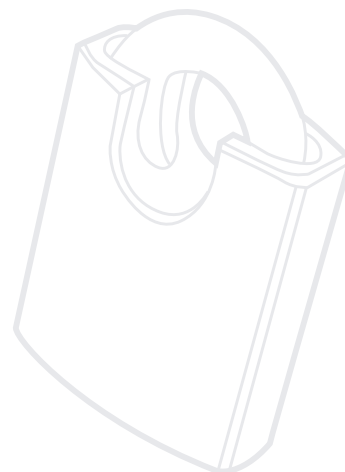



517



1950



1950

Anse amovible et réglable multi-positions de 70 à 140 mm. Corps acier laminé traité. Cylindre bouterollé.

Removable and adjustable shackle from 70 to 140 mm. Treated laminated steel body. Warded keyway.

Anse acier cémenté amovible et réglable multi-positions de 70 mm à 155 mm.

Removable and adjustable hardened steel shackle from 70 mm to 155 mm.

Cadenas anse amovible/Removable shackle padlocks

Référence/Reference	517EURD	1950EURD	8080EURD
Largeur du corps/Body width	45 mm	50 mm	80 mm
Diamètre de l'anse/Shackle diameter	7 mm	8 mm	15 mm
Hauteur d'anse/Shackle length	70-140 mm	70-155 mm	195 mm
Ecartement de l'anse/Horiz. shackle clearance	21 mm	25 mm	43 mm
Corps/Body			
Laiton/Brass		•	•
Protection vinyle anti-corrosion/Anti-rust vinyl cover			•
Acier laminé/Laminated steel	•		
Anse/Shackle			
Acier std./Std. steel	•		
Acier cémenté/Hardened steel		•	•
Double verrouillage/Double locking	•	•	•
Cylindre/Cylinder			
Nombre de goupilles/Number of pins	5	5	5
Protection de serrure/Snap on cap			•
Nombre de clés/Number of keys	2	2	2



8080

Anse amovible en acier cémenté. Très bonne résistance au sciage et au coupe-boulon. Protection vinyle noire. Résiste à la corrosion.

Removable hardened steel shackle. Good resistance against sawing and bolt-cutting. Protective vinyl cover. Corrosion resistant.

CADENAS ACIER LAMINÉ

LAMINATED STEEL PADLOCKS

La famille de cadenas la plus vendue sur le marché américain.

Depuis plus de 90 ans, Master Lock® fabrique des cadenas en acier laminé de haute qualité avec cylindre à goupilles de précision.

Cette gamme est disponible avec anse en acier cémenté à double verrouillage et corps en acier laminé extrêmement résistant au martelage, aux chocs et tentatives d'effraction.

De nombreuses options de hauteur d'anse sont disponibles.

Cadenas en acier laminé : le corps le plus résistant pour un cadenas de sécurité générale.



Cadenas acier laminé. *Laminated steel padlocks.*
Anse double verrouillage. *Double locking shackle.*
Cylindre à goupilles. *Pin tumbler cylinder.*



3



3LF



1LJ



3

Cadenas anse amovible/Removable shackle padlocks

Référence/Reference	3EURD	3EURDLF	3EURT	3008EURD	1EURD	1EURDLJ
Largeur du corps/Body width	40 mm	40 mm	40 mm	40 mm	45 mm	45 mm
Diamètre de l'anse/Shackle diameter	7 mm	7 mm	7 mm	7 mm	8 mm	8 mm
Hauteur d'anse/Shackle length	19 mm	38 mm	19 mm	19 mm	24 mm	64 mm
Ecartement de l'anse/Horiz. shackle clearance	16 mm	16 mm	16 mm	16 mm	19 mm	21 mm
Corps/Body						
Acier laminé/Laminated steel	•	•	•	•	•	•
Anse/Shackle						
Acier cémenté/Hardened steel	•	•	•	•	•	•
Double verrouillage/Double locking	•	•	•	•	•	•
Cylindre/Cylinder						
Nombre de goupilles/Number of pins	4	4	4	4	4	4
Nombre de clés /Number of keys	2	2	2	4	2	2
Cadenas s'ouvrant/Keyed alike padlocks						
Une même clé ouvre tous les cadenas/Same key opens all padlocks						
Nombre de cadenas/Number of padlocks			2	4		

The largest volume padlock sold on the American market.

For more than 90 years, Master Lock® has manufactured extra tough laminated padlocks with pin tumbler cylinders.

The collection of pin tumbler locks offers dual locking hardened steel shackles and tough laminated steel bodies which stand up to physical abuse for dependable protection against theft.

Numerous optional shackle lengths are available. Laminated steel body: the strongest padlock body for general security.

Les cadenas aluminium offrent une alternative aux cadenas plus traditionnels.

De forme diamant, leur finition métal brossé leur donne une image plus moderne et plus sobre qui s'inscrit dans les tendances actuelles.

Disponibles en 4 tailles et en multiples hauteurs d'anse, ils répondent à tout type d'application.

Ils offrent toutes garanties en terme de sécurité et présentent une bonne résistance aux intempéries.



Aluminium padlocks are a great alternative to classic padlocks.

The diamond shaped design is finished in brushed metal and gives the padlocks a modern, contemporary look.

Available in 4 different sizes the range is suitable for a wide range of applications.

The aluminium padlocks are secure and also have a good level of weather resistance.

Cadenas aluminium finition métal brossé/Aluminium padlocks brushed metal finish

Référence/Reference	9120EURD	9120EURT
Largeur du corps/Body width	20 mm	20 mm
Diamètre de l'anse/Shackle diameter	3 mm	3 mm
Hauteur d'anse/Shackle length	11 mm	11 mm
Ecartement de l'anse/Horiz. shackle clearance	10 mm	10 mm
Corps/Body		
Aluminium/Aluminium	•	•
Anse/Shackle		
Acier std./Std. steel	•	•
Acier cémenté/Hardened steel		
Simple verrouillage/Simple locking	•	•
Double verrouillage/Double locking		
Cylindre/Cylinder		
Nombre de goupilles/Number of pins	3	3
Nombre de clés/Number of keys	2	2
Cadenas s'ouvrant/Keyed alike padlocks <small>Une même clé ouvre tous les cadenas/Same key opens all padlocks</small>		•
Nombre de cadenas/Number of padlocks		2

FINITION MÉTAL BROSSÉ BRUSHED METAL FINISH

Corps monobloc aluminium. *Solid aluminium case.*
 Anse en acier cémenté. *Hardened steel shackle.*
 Cylindre à goupilles. *Double locking.*
 Double verrouillage. *Pin tumbler cylinder.*



9130



9120



9130



9130LJ



9140



9140LF



9140LH



9150



9150LJ

9120EURQNOP	9130EURD	9130EURT	9130EURDLJ	9140EURD	9140EURT	9140EURQNOP	9140EURDLF	9140EURDLH	9150EURD	9150EURDLJ
20 mm	30 mm	30 mm	30 mm	40 mm	40 mm	40 mm	40 mm	40 mm	50 mm	50 mm
3 mm	5 mm	5 mm	5 mm	6 mm	6 mm	6 mm	6 mm	6 mm	7 mm	7 mm
11 mm	18 mm	18 mm	64 mm	21 mm	21 mm	21 mm	38 mm	51 mm	25 mm	64 mm
10 mm	14 mm	14 mm	14 mm	21 mm	21 mm	21 mm	21 mm	21 mm	25 mm	25 mm
•	•	•	•	•	•	•	•	•	•	•
•	•	•	•	•	•	•	•	•	•	•
•	•	•	•	•	•	•	•	•	•	•
3	4	4	4	4	4	4	4	4	5	5
4	2	2	2	2	2	4	2	2	2	2
•		•			•	•				
4		2			2	4				

La gamme de cadenas aluminium Master Lock® se décline en couleurs variées : pastel, classiques ou noir pour répondre à tous les goûts et à toutes les humeurs.

En 20 mm, ils sont idéals pour personnaliser un bagage et l'identifier plus rapidement.

En 30 mm, ils apportent une touche originale sur un sac de sport ou une porte vestiaire.

Quelle que soit la couleur, le revêtement vinyle permet de protéger des chocs et des rayures les surfaces que le cadenas sécurise.



The Master Lock® aluminium range is available in a variety of colours including pastel, classic or black to suit all tastes.

The 20 mm size is perfect to use with luggage when travelling, while the 30 mm size can be used on a sports bag or a locker.

The vinyl cover also helps to protect secured surfaces from scratching.

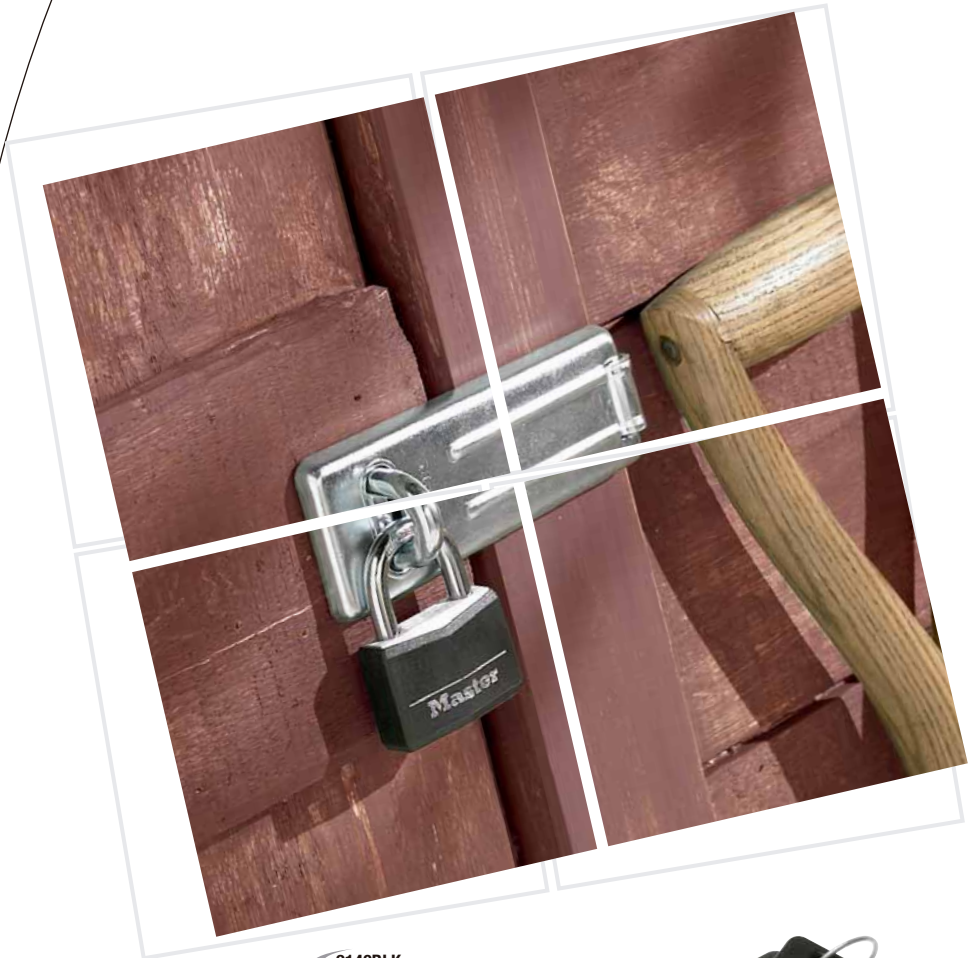

9140BLK



Cadenas aluminium - protection vinyle noire

Référence/Reference

Largeur du corps/Body width

Diamètre de l'anse/Shackle diameter

Hauteur d'anse/Shackle length

Ecartement de l'anse/Horiz. shackle clearance

Corps/Body

Aluminium/Aluminium

Protection vinyle noire anti-corrosion/Anti-rust black vinyl cover

Anse/Shackle

Acier std./Std. steel

Acier cémenté/Hardened steel

Simple verrouillage/Simple locking

Double verrouillage/Double locking

Cylindre/Cylinder

Nombre de goupilles/Number of pins

Nombre de clés /Number of keys

Cadenas s'ouvrant/Keyed alike padlocks

Une même clé ouvre tous les cadenas/Same key opens all padlocks

Nombre de cadenas/Number of padlocks

PROTECTION VINYLE NOIRE

BLACK VINYL COVER

Corps monobloc aluminium avec protection vinyle
noire anti-choc/anti-rayure/anti-corrosion.
Anse en acier cémenté.
Double verrouillage.
Cylindre à goupilles.
Tête de clé de couleur assortie.

*Solid aluminium body with black cover
protects from scratching and corrosion.
Hardened steel shackle.
Double locking.
Pin tumbler cylinder.
Coloured matched key head.*



9120BLK



9130BLK



9140BLK



9140BLKLF



9140BLKLH



9150BLK



9150BLKLH

Aluminium padlocks - black vinyl cover

9120EURDBLK 9120EURTBK 9120EURQBLKNOP 9130EURDBLK 9130EURTBK 9140EURDBLK 9140EURTBK 9140EURQBLKNOP 9140EURDBKLF 9140EURDBKLFH 9150EURDBLK 9150EURDBKLFH

20 mm	20 mm	20 mm	30 mm	30 mm	40 mm	40 mm	40 mm	40 mm	40 mm	40 mm	50 mm	50 mm
3 mm	3 mm	3 mm	5 mm	5 mm	6 mm	6 mm	6 mm	6 mm	6 mm	6 mm	7 mm	7 mm
11 mm	11 mm	11 mm	18 mm	18 mm	21 mm	21 mm	21 mm	38 mm	51 mm	25 mm	51 mm	51 mm
10 mm	10 mm	10 mm	14 mm	14 mm	21 mm	21 mm	21 mm	21 mm	21 mm	25 mm	25 mm	25 mm

•	•	•	•	•	•	•	•	•	•	•	•	•
•	•	•	•	•	•	•	•	•	•	•	•	•

•	•	•	•	•	•	•	•	•	•	•	•	•
•	•	•	•	•	•	•	•	•	•	•	•	•

3	3	3	4	4	4	4	4	4	4	5	5	5
2	2	4	2	2	2	2	4	2	2	2	2	2
	•	•		•	•	•	•	•				
	2	4		2		2	4					



Corps monobloc aluminium avec protection vinyle couleur anti-choc/anti-rayure/anti-corrosion.
Anse en acier cémenté.
Cylindre à goupilles.
Tête de clé de couleur assortie.

*Solid aluminium body with colour vinyl cover that protects from scratching and corrosion.
Hardened Steel Shackle.
Pin tumbler cylinder.
Colour matched key head.*

COULEURS CLASSIQUES / CLASSIC COLOURS



Disponible en 20, 30 et 40 mm.
Available in 20, 30 and 40 mm.

COULEURS PASTEL / PASTEL COLOURS



COULEURS DÉGRADÉES / SHADED TONES



Anse en acier.
Disponible en 20 mm.

*Steel shackle.
Available in 20 mm.*

Cadenas aluminium - protection vinyle couleur

Référence/Reference

Largeur du corps/Body width

Diamètre de l'anse/Shackle diameter

Hauteur d'anse/Shackle length

Ecartement de l'anse/Horiz. shackle clearance

Corps/Body

Fer/Iron

Aluminium/Aluminium

Protection vinyle noire anti-corrosion/Anti-rust black vinyl cover

Couleurs pastel/Pastel colours

Couleurs classiques/Classic colours

Couleurs dégradées/Shaded tones

Imprimés sport/Printed patterns

Anse/Shackle

Acier/Steel

Acier cémenté/Hardened steel

Simple verrouillage/Simple locking

Double verrouillage/Double locking

Cylindre/Cylinder

Nombre de goupilles/Number of pins

Nombre de clés/Number of keys

Cadenas s'ouvrant/Keyed alike padlocks

Une même clé ouvre tous les cadenas/Same key opens all padlocks

Nombre de cadenas/Number of padlocks

Master Lock® révolutionne l'univers du cadenas en créant un cadenas qui répond aux attentes des consommateurs en matière de design tout en alliant solidité et performance. Son design moderne et innovant se décline en 4 couleurs tendances ou en finition nickelée très sophistiquée. Son anse est en acier cémenté pour une meilleure résistance au sciage.

La position frontale de sa serrure le rend vraiment facile à utiliser. Il est livré avec 2 clés dont la tête est identique au design du cadenas pour une meilleure identification.

Il est disponible en format bagage (20 mm) ou en 40 mm selon l'usage et le niveau de protection souhaités.

La FUSION réussie de la sécurité et du design.

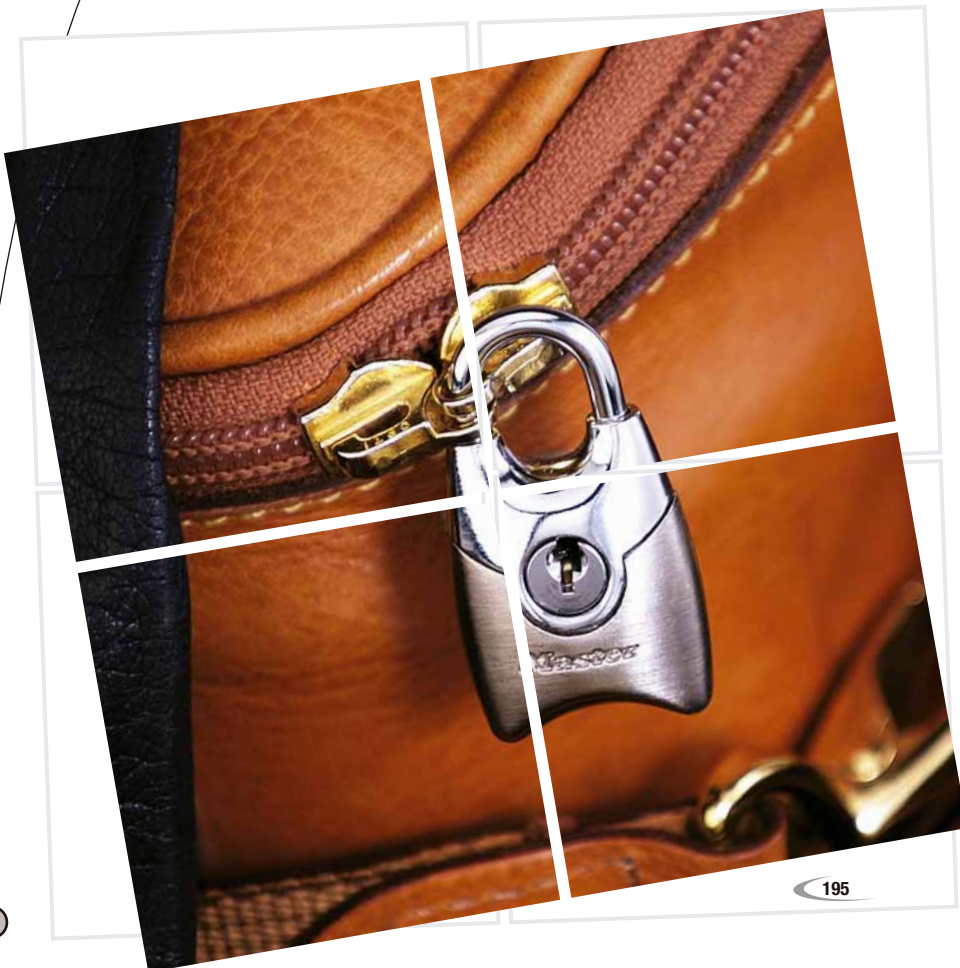

195

Master Lock® revolutionised the padlock world by creating a padlock that meets consumers' needs in term of design, strength and performance. Fusion™ modern and innovative shape is available in 4 trendy colours or in a sophisticated nickel finish.

Shackle is made of hardened steel for better cut resistance.

Fusion™ locks have a convenient front access keyway.

Fusion™ locks are supplied with 2 keys with a distinctive key head design to match the shape and colour of the lock body for easier identification.

Fusion™ padlocks are available in 20 mm for luggage and 40 mm depending on the application desired.

Design and security FUSION.

Finition nickelée.
Anse protégée en acier.
Double verrouillage
à pêne dormant.

Nickel finish.
Shrouded steel shackle.
Double locking.
Key retaining.



195



4630

Existe en 4 couleurs. Available in 4 different colours.
 Tête de clé assortie à la couleur Matching colour key head.
 du cadenas. Chrome plated lexan and zinc body.
 Corps en lexan et zinc chromé. Double locking.
 Double verrouillage à pêne dormant. Key retaining.



4630



192

FUSION™					
Référence/Reference	195EURT	195EURQ	4630EURT	4630EURQ	192EURD
Largeur du corps/Body width	20 mm	20 mm	20 mm	20 mm	44 mm
Diamètre de l'anse/Shackle diameter	3 mm	3 mm	3 mm	3 mm	6 mm
Hauteur d'anse/Shackle length	10 mm	10 mm	10 mm	10 mm	18 mm
Ecartement de l'anse/Horiz. shackle clearance	10 mm	10 mm	10 mm	10 mm	19 mm
Corps/Body					
Zinc/Zinc	•	•			
Lexan zinc chromé/Lexan chrome plated zinc			•	•	•
Anse/Shackle					
Acier/Steel	•	•	•	•	
Acier cémenté/Hardened steel					•
Anse protégée/Shrouded shackle	•	•	•	•	•
Cylindre/Cylinder					
Double verrouillage/Double locking					•
Nombre de clés /Number of keys	2	4	2	4	2
Cadenas s'ouvrant/Keyed alike padlocks					
Une même clé ouvre tous les cadenas/Same key opens all padlocks	•	•	•	•	
Nombre de cadenas/Number of padlocks	2	4	2	4	

Aux Etats-Unis, dans les aéroports, les agents officiels de la TSA (Administration de la Sécurité des Transports) sont autorisés pour des raisons de sécurité à ouvrir tous les bagages, quitte à endommager cadenas et serrures.

Avec les cadenas Master Lock® agréés Travel Sentry®, seuls les agents officiels de la TSA peuvent ouvrir les bagages avec un passe spécial, les inspecter puis les refermer pour qu'ils restent sécurisés.

Master Lock® propose toute une gamme de cadenas agréés Travel Sentry®, ils sont reconnaissables au logo. 



In United States airports, the Transportation Security Administration (TSA) screeners will, for security reasons, open most luggage even if they have to damage the lock or padlock.

With the Master Lock® Travel Sentry® approved padlocks, TSA screeners are able to unlock the luggage with a secure system, inspect and relock them so that baggage is secure for the remainder of the journey.

The Master Lock® Travel Sentry® approved products are recognizable with the Travel Sentry® logo. 

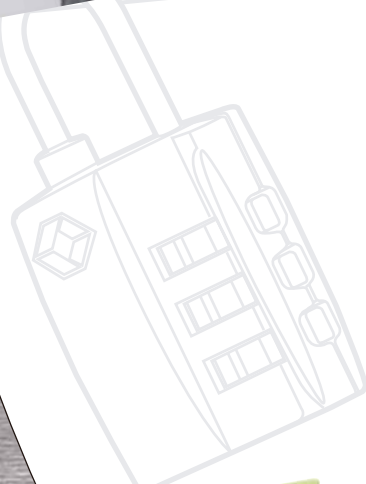

Cadenas certifié "TSA". Câble en acier tressé flexible avec protection vinyle. Disponible en 4 couleurs acidulées et tendance.

"TSA" accepted padlock. Flexible braided steel cable with vinyl protective cover. Available in 4 radiant and trendy colours.





TRAVEL SENTRY®

lock. protect. relax.



4680NKL



4680BLK

Cadenas certifié "TSA".
Combinaison programmable à 3 chiffres.
L'anse se glisse dans la plupart des
fermetures éclair des sacs
valises ou malettes.

"TSA" accepted padlock.
3-digit resettable
combination.
Shackle fits through most
luggage zipper pulls.



4686

Lot de 2 cadenas certifiés "TSA".
Combinaison programmable
à 3 chiffres.
Existe en noir, rouge,
bleu et violet.

Pack of 2 "TSA"
accepted padlocks.
3-digit resettable combination.
Available in black, red,
blue and purple.



4681BLR



4681BLK



Cadenas certifié "TSA"
Corps recouvert d'une protection en plastique ABS.
Lot de 2 cadenas s'ouvrant.
Ses couleurs permettent une identification rapide des bagages.
Existe en bleu, rouge et noir.

"TSA" accepted padlock.
Body with ABS vinyl protective cover.
Pack of 2, keyed alike.
Bright colours help quickly identify luggage.
Available in blue, red and black.



Cadenas certifiés TSA/TSA-accepted padlocks

Référence/Reference	4680EURDBLK	4680EURDNKL	4681EURTBK	4681EURTLR	4686EUR	4688EUR
Largeur du corps/Body width	30 mm	30 mm	32 mm	32 mm	35 mm	30 mm
Diamètre de l'anse/Shackle diameter	3 mm	3 mm	3 mm	3 mm	3 mm	3 mm
Hauteur d'anse/Shackle length	19 mm	19 mm	15 mm	15 mm	20 mm	40 mm
Ecartement de l'anse/Horiz. shackle clearance	13 mm	13 mm	11 mm	11 mm	14 mm	15 mm
Corps/Body						
Aluminium/Aluminium			•	•		
Protection ABS/ABS protected			•	•	•	
Acier traité/Die-cast	•	•				
Zinc/Zinc					•	•
Anse/Shackle						
Acier Std./Std. steel	•	•	•	•	•	
Acier tressé et protection vinyle/Braided steel & vinyl cover						•
Cylindre/Cylinder						
Nombre de goupilles/Number of pins			3	3		
Nombre de clés /Number of keys			4	4		
Combinaison/Combination						
3 chiffres programmables/3-digit programmable	•	•			•	•
Cadenas s'ouvrant/Keyed alike padlocks						
Une même clé ouvre tous les cadenas/Same key opens all padlocks			•	•		
Nombre de cadenas/Number of padlocks			2	2	2	

De nombreux consommateurs préfèrent ne pas s'embarasser de clés et optent pour des cadenas à combinaison.

Avec les cadenas à combinaison programmable, l'utilisateur peut même entrer son propre code et le modifier à tout moment.

La gamme Master Lock® propose un large choix de cadenas à combinaison fixe ou programmable :

- Des cadenas bagages pratiques, au design innovant, pour la protection des valises, sacs à dos, malettes, housses d'ordinateur portable...
 - Des cadenas d'utilisation plus générale et tout aussi innovants pour par exemple, vestiaires de salles de sport, d'écoles, de centres de remise en forme et autres usages divers.
 - Des câbles antivols d'appoint pour valises, poussettes ou rollers.
- La sécurité sans souci de clé.

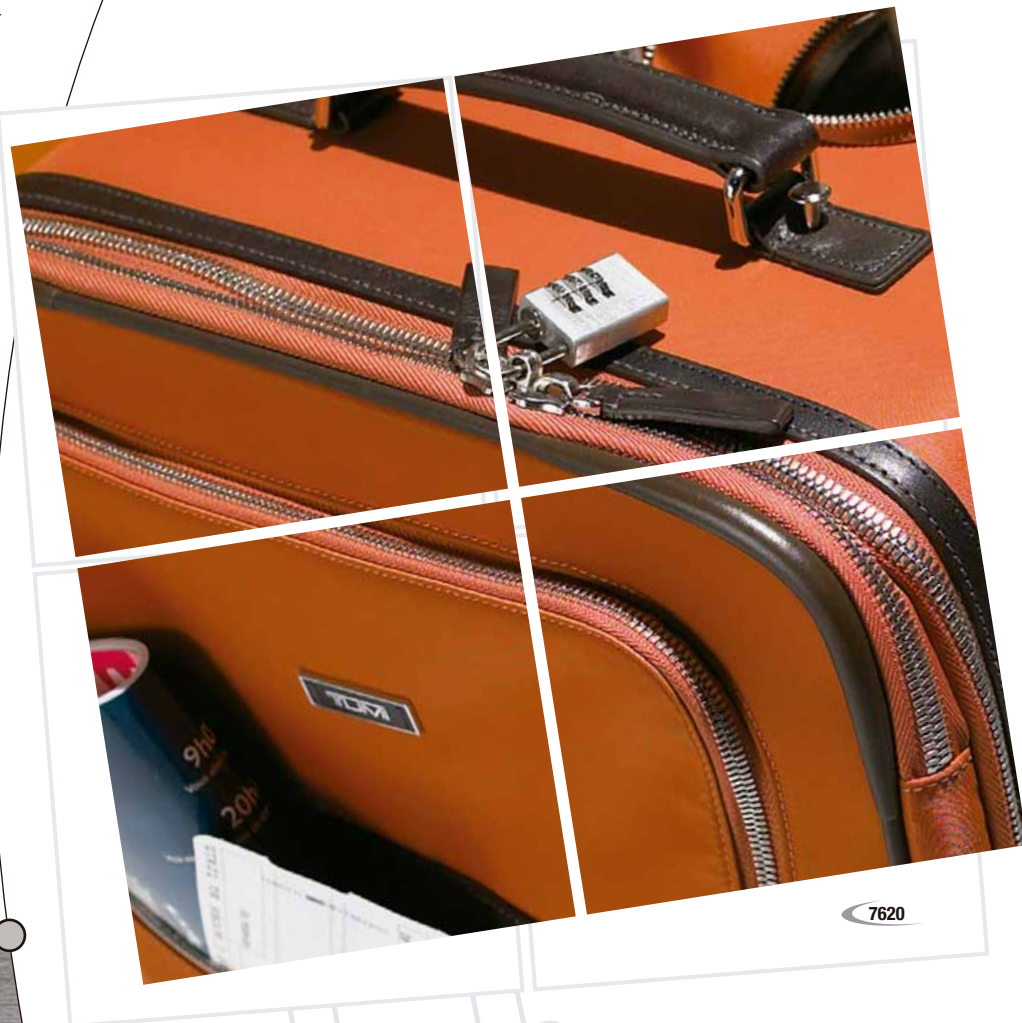

Some consumers prefer the keyfree convenience of a combination padlock.

With the Master Lock® "set-your-own combination" padlocks, a simple process allows the user to set a combination that is easy to remember because it is truly personal.

The Master Lock® range offers a wide choice of padlocks with either resettable or fixed combination, such as:

- *The luggage locks with innovative design provide the convenience that the consumers deserve when they travel.*
- Ideal to secure suitcases, travel bags, sports bags, backpacks...*
- *The general and innovative purpose combination padlocks for school lockers, gym lockers, sheds, gates, bikes and numerous other applications.*
- *Small retractable cable locks for luggage, pushchair and roller.*

Cadenas à combinaison/Combination padlocks

Référence/Reference

Largeur du corps/Body width

Diamètre de l'anse/Shackle diameter

Hauteur d'anse/Shackle length

Ecartement de l'anse/Horiz. shackle clearance

Corps/Body

Finition laiton/Brass finish

Zinc/Zinc

Aluminium/Aluminium

Anse/Shackle

Acier plaqué laiton/Brass plated steel

Acier plaqué nickel/Nickel plated Steel

Simple verrouillage/Simple locking

Combinaison/Combination

3 chiffres programmables/3 resettable digits

Nombre de cadenas/Number of padlocks

PROGRAMMABLE
RESETTABLE

NOIR / BLACK



621BLK



646



647



630BLU

FINITION LAITON
BRASS FINISH



620



630

MÉTAL BROSSÉ
BRUSHED
METAL FINISH



7620



7630

COULEURS LAQUÉES / LACQUERED COLOURS



7620COL



7620WHI



630BLU



7630COL

620EURD	630EURD	621EURDBLK	646EURD	646EURT	647EURD	7620EURD	7620EURT	7620EURWHI	7620EURCOL	7620EURTCOL	7630EURD	7630EURDCOL	630EURDBLU
20 mm	30 mm	20 mm	20 mm	20 mm	30 mm	20 mm	20 mm	20 mm	20 mm	20 mm	30 mm	30 mm	30 mm
3 mm	5 mm	3 mm	3 mm	3 mm	5 mm	3 mm	3 mm	3 mm	3 mm	3 mm	5 mm	5 mm	5 mm
21 mm	25 mm	19 mm	22 mm	22 mm	24 mm	21 mm	21 mm	21 mm	21 mm	21 mm	24 mm	24 mm	25 mm
9 mm	14 mm	9 mm	9 mm	9 mm	14 mm	9 mm	9 mm	9 mm	9 mm	9 mm	14 mm	14 mm	14 mm

•	•		•	•	•		•	•	•	•	•	•	•
•	•	•	•	•	•	•	•	•	•	•	•	•	•
•	•	•	•	•	•	•	•	•	•	•	•	•	•
•	•	•	•	•	•	•	•	•	•	•	•	•	•
				2				2			2		

IMPRIMÉS / PRINTED PATTERNS



1509LOV



632PAT



1509LOV



633T



633



633

PROGRAMMABLE RESETTABLE

CADENAS PORTE-ADRESSE / ADDRESS LABEL PADLOCK



4684



4670COL



4671COL

Combinaison programmable à 3 chiffres. 3-digit resettable combination.
4 couleurs vives. 4 radiant colours.



4684COL



4671COL

Combinaison programmable à 3 chiffres. 3-digit resettable combination.
Câble acier flexible. Flexible steel cable.
4 couleurs pop. 4 pop colours.

Cadenas à combinaison/Combination padlocks

Référence/Reference	4684EURD	4684EURTCOL	4670EURDCOL	4671EURDCOL	1509EURDLOV	632EURDPAT	633EURD	633EURT
Largeur du corps/Body width	30 mm	30 mm	44 mm	42 mm	30 mm	30 mm	32 mm	32 mm
Diamètre de l'anse/Shackle diameter	2 mm	2 mm	3 mm	3 mm	5 mm	5 mm	4 mm	4 mm
Hauteur d'anse/Shackle length	65 mm	46 mm	20 mm	44 mm	22 mm	19 mm	17 mm	17 mm
Ecartement de l'anse/Horiz. shackle clearance	20 mm	20 mm	13 mm	20 mm	14 mm	14 mm	11 mm	11 mm
Corps/Body								
Zinc/Zinc	•	•				•	•	•
Zamak/Zamak					•			
Plastique ABS/ABS plastic			•	•				
Anse/Shackle								
Acier/Steel			•	•	•	•	•	•
Câble acier tressé & protection vinyle/Braided steel & vinyl cover cable	•	•		•				
Simple verrouillage/Simple locking	•	•	•		•	•	•	•
Combinaison/Combination								
3 chiffres programmables/3 resettable digits	•	•	•	•	•	•	•	•
Nombre de cadenas/Number of padlocks		2			2			2



1535COL

CADENAS VERTICAL / VERTICAL PADLOCK



1535COL

Combinaison programmable à 4 chiffres. / 4-digit resettable combination.
4 couleurs / 4 colours



Existe aussi à l'unité - gris
Also sold singly - grey

1535GRY

PRO SPORT / PRO SPORT



1520

Combinaison programmable à 4 chiffres. / 4-digit resettable combination.



1523



1534

Combinaison programmable à 4 chiffres ou lettres. / 4-digit or letter resettable combination.
Avec molettes supplémentaires. / With extra wheels for more options.



1523

DESIGN UNIQUE / UNIQUE DESIGN



654

Gomme latérale colorée.
Disponible en 34, 41 et 50 mm.

Soft-touch rubber grips.
Available in 34, 41 and 50 mm.



652



4603

Câble 70 mm ajustable et rétractable. 70 mm retractable and adjustable steel cable.

DESIGN CLASSIQUE / CLASSIC DESIGN

Finition laiton
Brass finish

Combinaison programmable
à 4 chiffres.
4-digit resettable
combination.



604

Aluminium
Aluminium



7640

Aluminium peint
Aluminium painted



7640BLK



7640BLKLH

Cadenas à combinaison/Combination padlocks

Référence/Reference	604EURD	7640EURD	7640EURDBLK	7640EURDBLKLH	1520EURD	1523EURD	1534EURD	1535EURDCOL	1535EURDGRY	652EURD	654EURD	653EURD	4603EURD
Largueur du corps/Body width	40 mm	40 mm	40 mm	40 mm	64 mm	64 mm	64 mm	37 mm	37 mm	34 mm	41 mm	50 mm	51 mm
Diamètre de l'anse/Shackle diameter	6 mm	6 mm	6 mm	6 mm	7 mm	7 mm	7 mm	7 mm	7 mm	3 mm	5 mm	6 mm	-
Diamètre de câble/Cable diameter	-	-	-	-	-	-	-	-	-	-	-	-	2 mm
Hauteur d'anse/Shackle length	26 mm	27 mm	27 mm	51 mm	26 mm	26 mm	26 mm	22 mm	22 mm	20 mm	22 mm	24 mm	-
Ecartement de l'anse/Horiz. shackle clearance	22 mm	22 mm	22 mm	22 mm	36 mm	36 mm	36 mm	17 mm	17 mm	13 mm	16 mm	19 mm	-
Longueur de câble/Cable length	-	-	-	-	-	-	-	-	-	-	-	-	70 cm
Corps/Body													
Finition laiton/Brass finish	•												
Aluminium/Aluminium		•	•	•									
Acier traité/Die-cast					•	•	•						
Zinc/Zinc								•	•	•	•	•	
Anse/Shackle													
Acier/Steel	•	•	•	•						•	•	•	•
Acier cémenté/Hardened steel					•	•	•	•	•		•	•	•
Protection vinyle/Vinyl cover													•
Simple verrouillage/Simple locking	•	•	•	•				•	•	•	•	•	
Double verrouillage/Double locking					•	•	•						
Combinaison/Combination													
3 chiffres programmables/3 resettable digits										•	•		•
4 chiffres programmables/4 resettable digits	•	•	•	•	•	•	•	•	•			•	
4 lettres programmables/4 resettable letters								•					

Ceux pour qui mémoriser un code relève du supplice ou dont le porte-clés est déjà surchargé, One® est le cadenas idéal !

Son système de verrouillage exclusif permet d'ouvrir One® en quelques mouvements de pouce en faisant glisser le bouton central :

haut, bas, bas, droite, gauche, bas...

Ouvrir son cadenas devient aussi simple que de naviguer sur son iPod® !

La suite de mouvements est programmable et reprogrammable à l'infini.

De 2 à 99 impulsions, à chacun de trouver sa propre chorégraphie !

Décliné en 2 couleurs laquées, il apporte une touche pop partout où il s'installe.

A la piscine, la salle de sport, à l'école, sur la porte de la cave ou dans la maison, One® est le cadenas idéal pour sécuriser ses affaires au quotidien.



**Plus besoin de clés,
plus de combinaison
à retenir !**

**No need for keys,
no combination
to remember!**



One is the perfect lock for those who would rather not have to memorize a combination code and already have too many keys.

The Master Lock® One® has a unique locking system that allows the lock to be opened with a simple thumb movement by sliding the central button according to set directional motions: e.g. up, down, left, right. These can be set and reset and can include from 2 to 99 pulses.

Opening One® lock is as easy as browsing on an iPod®!

With its round and ergonomic shape One® is easy to hold and great to look at and comes in 2 glossy colours.

At the swimming pool, the gym, school, the office, or around the house, One® is the perfect lock to secure belongings without the fuss of keys or a combination.



1500iBLK



1500iWHI

**Le premier cadenas qui s'ouvre
d'un simple coup de pouce !**

**The first padlock that
opens with one thumb!**



COMBINAISON "COFFRE-FORT" "SAFETY BOX" COMBINATION

COMBINAISON PROGRAMMABLE / RESETTABLE COMBINATION



1590COL



C'est en étant à l'écoute des goûts en matière de design et besoins en termes de sécurité de la jeune génération que Master Lock® a conçu ce cadenas rond et coloré.

Son cadran fluide se manipule facilement et agréablement et sa façon de composer la combinaison rappelle celle des coffres-forts. Le code est facilement personnalisable et modifiable à l'infini.

Ses 4 couleurs vives et tendance facilitent la personnalisation et l'identification de ses biens.

Master Lock® designed this round and coloured padlock specifically with the security and tastes of the younger generation in mind.

Its smooth dial handle, simple and easy to use, is similar to those found on safes and is easy to set and reset.

Its bright trendy colours come in blue, green, pink and black for customization and easy identification of its belongings.

COMBINAISON FIXE / FIXED COMBINATION



1533



1503



Cadenas à combinaison/Combination padlocks						
Référence/Reference	1500IEURDBLK	1500IEURDWHI	1590EURCOL	1503EURD	1530EURD	1533EURD
Largeur du corps/Body width	55 mm	55 mm	49 mm	48 mm	48 mm	38 mm
Diamètre de l'anse/Shackle diameter	7 mm	7 mm	7 mm	7 mm	7 mm	6 mm
Hauteur d'anse/Shackle length	27 mm	27 mm	23 mm	19 mm	19 mm	18 mm
Ecartement de l'anse/Horiz. shackle clearance	19 mm	19 mm	24 mm	21 mm	21 mm	17 mm
Corps/Body						
Acier inoxydable/Stainless steel				•	•	•
Zinc/Zinc	•	•	•			
Double blindage/Double armor			•	•	•	
Anse/Shackle						
Acier cémenté/Hardened steel	•	•	•	•	•	•
Double verrouillage/Double locking			•	•	•	
Combinaison/Combination						
3 chiffres fixes/3 fixed digits	•	•	•	•	•	•
2 à 99 mouvements/2 to 99 directional movements	•	•				



1530

Cadenas à combinaison fixe à 3 chiffres. Système de verrouillage type coffre-fort. Couleurs assorties. 1500 combinaisons possibles.

3-digit fixed combination padlock. Assorted colours. 1500 possible combinations.

Master Lock® propose une gamme étendue de mousquetons qui se renouvellent au gré des collections.

Sans combinaison, avec leurs couleurs acidulées, ils s'utilisent comme porte-clé ou comme accessoire que l'on peut changer tous les jours puisqu'ils sont disponibles en 4 couleurs.

A combinaison programmable, ils protègent sacs à dos, sacs de voyages ou sacs de sport.

L'étendue de la collection permet au consommateur de laisser libre court à ses envies : forme arrondie, rectangulaire ou demi-lune, finition métal, couleurs anodisées ou laquées...

Il ne reste plus qu'à choisir !

SANS COMBINAISON / NON LOCKING



1270CAR-BOWL

Mousqueton 76 mm en acier zingué.
76 mm zinc die-cast carabiner.



603

Mousqueton 52 mm en aluminium.
52 mm aluminium carabiner.



4673



1270CAR-DIS



603

Master Lock® offers a wide range of carabiners that is constantly being updated. The non locking carabiner has multiple uses including keyrings or as bag accessories. They are lightweight and come in 4 metallic colours; red, blue, purple and green.

The locking carabiner has all the features of the non locking version but with the added benefit of a resettable combination.

They can secure backpacks, travel bags or sports bags. Consumers can choose from round, rectangular or half moon shapes, metal finish, anodised or lacquered colours.

Mousquetons/Carabiners				
Référence/Reference	4673EURT	603EURQ	1270CAR-BOWL	1270CAR-DIS
Longueur du corps/Body length	52 mm	76 mm	76 mm	76 mm
Corps/Body				
Aluminium/Aluminium	•			
Acier zingué/Zinc die-cast		•	•	•
Quantité/Quantity				
Nombre de mousquetons/Number of carabiners	2	4	100	150

COMBINAISON PROGRAMMABLE / RESETTABLE COMBINATION



1550COL



1550COL



1547COL



1555COL



CÂBLE D'ATTACHE À UN POINT FIXE CABLE FOR SECURING TO A FIXED POINT



1549COL



1551COL



1559COL



1547COL

Mousquetons à combinaison/Combination carabiners

Référence/Reference	1547EURDCOL	1549EURDCOL	1550EURDCOL	1551EURDCOL	1555EURDCOL	1559EURDCOL
Longueur du corps/Body length	84 mm	63 mm	84 mm	60 mm	78 mm	60 mm
Largeur du corps/Body width	47 mm	20 mm	38 mm	24 mm	27 mm	24 mm
Longueur du câble/Cable length				90 cm		90 cm
Anse/Schakle						
Diamètre/Diameter	5 mm	4 mm	5 mm	3 mm	5 mm	3 mm
Ecartement/Horiz. clearance	30 mm	15 mm	30 mm	13 mm	18 mm	13 mm
Corps/Body						
Acier zingué/Rugged die-cast	•	•	•	•	•	•
Combinaison/Combination						
3 chiffres/3-digits	•	•	•	•	•	•
Programmable/Programmable	•	•	•	•	•	•



SÉCURITÉ TOUTES INTEMPÉRIES

WEATHER TOUGH[®] SECURITY

L'utilisation d'un cadenas se fait parfois dans des conditions climatiques extrêmes : intempéries, neige, gel, environnement salin ou encore exposition prolongée au soleil.

MasterLock[®] a créé une gamme de cadenas, spécifique à ces conditions climatiques, qui allie sécurité et fiabilité. Sécurité car ils offrent une résistance maximum et fiabilité car quelles que soient les conditions endurées par le cadenas, son mécanisme fonctionne. Les cadenas Master Lock[®] bénéficient d'une **garantie à vie limitée**.

Padlocks are often used under extreme climatic conditions: bad weather, snow, corrosive environment or prolonged exposure to the sun.

MasterLock[®] has created a range of padlocks, secure and reliable, designed to resist these extreme climatic conditions. Secure, as they offer maximum resistance to attack and reliable as the lock mechanism will function whatever the conditions.

*All MasterLock[®] padlocks have a **limited lifetime guarantee**.*

Le cadenas Titanium Series™ est l'aboutissement d'études consommateurs intensives associées à l'innovation et la haute technologie.

Le corps en inox et le mécanisme de verrouillage sont garantis anti-rouille. Le mécanisme renforcé au Titane associe innovation technologique et fiabilité.

L'anse rotative dissuade toute tentative d'effraction à la barre de torsion.

Le cylindre accessible de face rend l'utilisation très pratique. Le design breveté et moderne répond aux attentes des consommateurs.

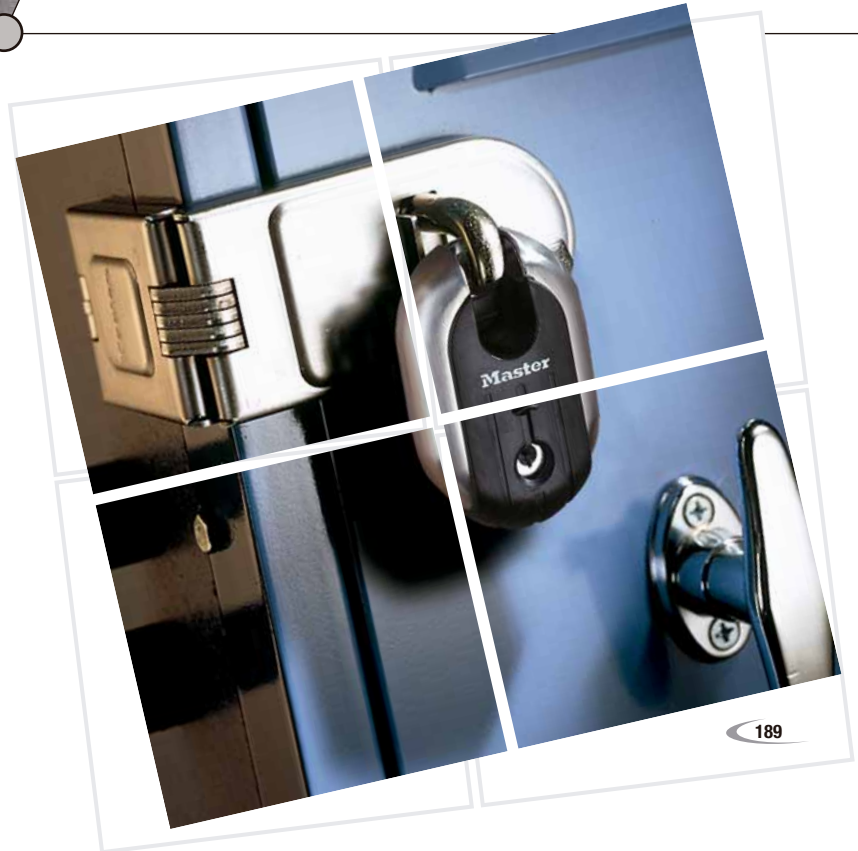

189



189

Titanium Series™ padlock is the result of extensive consumer research, innovation and new technology.

The stainless steel body and locking mechanism is guaranteed never to rust. The locking mechanism is titanium reinforced for high tech strength and reliability.

The closed body design and rotary shackle defies prying attacks.

It has a convenient front access keyway which allows single handed use. The patented and innovative styling responds to consumer demands.

Cadenas Titanium™/Titanium™ padlock

Référence/Reference	189EURD
Largeur du corps/Body width	49 mm
Diamètre de l'anse/Shackle diameter	7 mm
Hauteur d'anse/Shackle length	16 mm
Ecartement de l'anse/Horiz. shackle clearance	16 mm
Corps/Body	
Acier inoxydable/Stainless steel	•
Protection ABS/ABS protection	•
Anse/Shackle	
Acier cémenté/Hardened steel	•
Anse protégée/Shrouded shackle	•
Cylindre/Cylinder	
Nombre de goupilles/Number of pins	4
Retenue de clé/Key retaining	•
Protection de serrure/Snap on cap	•
Nombre de clés/Number of keys	2

PROTECTION THERMOPLASTIQUE

THERMOPLASTIC PROTECTION

Cadenas protection extérieure/Outdoor protection padlocks				
Référence/Reference	312EURD	312EURTRI	312EURDLH	317EURD
Largeur du corps/Body width	40 mm	40 mm	40 mm	40 mm
Diamètre de l'anse/Shackle diameter	10 mm	10 mm	10 mm	10 mm
Hauteur d'anse/Shackle length	25 mm	25 mm	51 mm	25 mm
Ecartement de l'anse/Horiz. shackle clearance	13 mm	13 mm	13 mm	13 mm
Corps/Body				
Acier/Steel	•	•	•	•
Protection thermoplastique/Thermoplastic cover	bleu/blue	bleu/blue	bleu/blue	camouflage
Anse/Shackle				
Acier cémenté/Hardened steel	•	•	•	•
Protection plastique/Plastic cover	•	•	•	•
Double verrouillage/Double locking	•	•	•	•
Cylindre/Cylinder				
Nombre de goupilles/Number of pins	4	4	4	4
Capuchon de serrure/Snap on cap	•	•	•	•
Nombre de clés/Number of keys	2	3	2	2
Cadenas s'ouvrant/Keyed alike padlocks		•		
<i>Une même clé ouvre tous les cadenas/Same key opens all padlocks</i>				
Nombre de cadenas/Number of padlocks		3		

Les cadenas pour protection extérieure Master Lock® garantissent une excellente sécurité et une haute résistance en milieu extérieur. Quel que soit le climat, ces cadenas fonctionnent année après année sous la pluie, la neige, la poussière et même dans le désert.

Le corps en acier est recouvert d'une protection thermoplastique haute technologie résistante aux températures extrêmes ainsi qu'aux expositions prolongées au soleil. L'anse double verrouillage est recouverte de plastique anti-corrosion.

Le cylindre à goupilles de sécurité est également protégé par un capuchon hermétique garantissant une très bonne protection contre l'humidité, la poussière et autres saletés.



312



317

Corps acier protection thermoplastique.
Anse double verrouillage.
Protection de serrure.

Steel body with thermoplastic cover.
Double locking shackle.
Snap on cap



317

Master Lock® coloured outside protection padlocks have a high tech thermoplastic shell that withstands extreme temperatures and exposure to sunlight without becoming brittle or cracked.

The double locking coated shackle affords extra protection with maximum flexibility. The quick snap-cap on the bottom protects the lock mechanism from weather, dust, dirt and even sand for long trouble-free performance.



312

Les cadenas utilisés en milieu marin sont très exposés aux intempéries et à l'air salin.

Une gamme de cadenas marine doit ainsi impérativement présenter une haute résistance à la corrosion.

Afin de répondre aux attentes des consommateurs, Master Lock® propose :

- des cadenas marine d'utilisation générale avec corps en laiton massif nickelé brossé et anse inox.
- des cadenas haute sécurité, tout inox, avec protection d'anse ou anse haute, double verrouillage à pêne dormant pour une résistance optimale à la corrosion et aux agressions.



550

Marine padlocks can be exposed to highly corrosive weather conditions.

A range of marine padlocks must be extremely resistant to corrosion.

In order to provide an appropriate reply to the consumers' s needs, MasterLock® offers:

- general security marine padlocks with nickel plated solid brass body and stainless steel shackle.
- high security, full stainless steel marine padlocks with shroud concealed shackle or long shackle, double deadbolt locking for maximum resistance against corrosion and attack.



40

Cadenas disque

Avec son anse rétractable en acier cémenté et son boîtier inox, le cadenas disque résiste à la corrosion et au coupe-boulon.

Discus lock

The shielded lock design minimizes shackle exposure, making it less vulnerable to cutting and sawing. Hardened steel shackle. Stainless steel body resists corrosion.



40

LAITON MASSIF NICKELÉ / NICKEL PLATED SOLID BRASS



Corps laiton massif nickelé / Nickel plated solid brass body
 Anse inox. / Stainless steel shackle.
 Double verrouillage. / Double locking.
 Retenue de clé. / Key retaining.



640

INOX / STAINLESS STEEL



Corps tout inox / Full stainless steel body
 Anse haute inox. / Long stainless steel shackle.
 Double verrouillage à billes. / Double ball bearing locking.
 Cylindre à goupilles. / Pin tumbler cylinder.

*Full stainless steel body
 Long stainless steel shackle.
 Double ball bearing locking.
 Pin tumbler cylinder.*



2340



550

Cadenas marine/Marine padlocks									
Référence/Reference	629EURQ	639EURD	639EURTRI	639EURDLJ	640EURD	640EURDLH	550EURD	2340EURDLH	40EURD
Largueur du corps/Body width	20 mm	30 mm	30 mm	30 mm	40 mm	40 mm	50 mm	40 mm	70 mm
Diamètre de l'anse/Shackle diameter	3 mm	5 mm	5 mm	5 mm	6 mm	6 mm	10 mm	7 mm	10 mm
Hauteur d'anse/Shackle length	12 mm	17 mm	17 mm	64 mm	23 mm	51 mm	22 mm	51 mm	19 mm
Ecartement de l'anse/Horiz. shackle clearance	10 mm	16 mm	16 mm	16 mm	20 mm	20 mm	23 mm	19 mm	19 mm
Corps/Body									
Laiton massif nickelé/Nickel plated solid brass	•	•	•	•	•	•			
Inox/Stainless steel							•	•	•
Anse/Shackle									
Inox/Stainless steel		•	•	•	•	•	•	•	
Acier/Steel	•								
Acier cémenté/Hardened steel									•
Double verrouillage/Double locking		•	•	•	•	•	•	•	•
À pêne dormant/Deadbolt locking					•	•	•	•	•
Cylindre/Cylinder									
Nombre de goupilles/Number of pins	3	4	4	4	5	5	5	5	4
Retenue de clé/Key retaining					•	•	•	•	•
Nombre de clés/Number of keys	4	2	3	2	2	2	2	2	2
Cadenas s'ouvrant/Keyed alike padlocks									
Une même clé ouvre tous les cadenas/Same key opens all padlocks	•		•						
Nombre de cadenas/Number of padlocks	4		3						

Un design breveté et des performances maximales

Master Lock® Excell® est la première gamme de cadenas haute sécurité qui s'adaptent à tous les supports, à toutes les configurations d'usage et à toutes les conditions climatiques.

Les cadenas « toutes intempéries » de la gamme Excell® offrent une multiplicité de formes, tailles et matériaux pour répondre au plus grand nombre de besoins :

- La série de cadenas en acier laminé avec protection thermoplastique pour résister au froid et aux intempéries se décline en différentes tailles et hauteurs d'anse pour s'adapter à un large panel d'utilisations.

Elle est idéale pour sécuriser portails, remises, portes de garage, rideaux de magasin...

- Les cadenas en inox à anse protégée offrent une protection maximale au coupe-boulon. Avec un corps et un cylindre en acier inoxydable, ces cadenas sont extrêmement résistants aux conditions climatiques les plus agressives (gel, corrosion marine...). Ils sont tout particulièrement recommandés pour protéger bateaux, portails, remorques...

A patented design delivering Maximum performance

Master Lock Excell is the first range of padlocks to offer maximum security and strength combined with versatility and weather resistance.

Excell® Weather Tough® padlocks are available in different sizes, shapes, quantities and materials to meet a wide variety of needs and applications:

- *Laminated steel padlocks come with a thermoplastic cover for protection against bad weather and are particularly strong in cold conditions. They are available in multiple sizes and shackle's lengths to meet a broad range of uses and are ideal to secure gates, garages doors, storefront gates and much more.*

- *Stainless steel padlocks have a shrouded shackle that offers maximum protection against bolt-cutters.*

The stainless steel construction also makes the locks highly resistant to extreme weather conditions (frost, sea corrosion...).

They are particularly recommended for the protection of boats, gates, trailers and much more.



M115LF



M40

PROTECTION THERMOPLASTIQUE THERMOPLASTIC COVER

EXCELL®

Corps en acier laminé.
Protection thermoplastique.
Anse octogonale
en alliage de bore.

Laminated steel body.
Thermoplastic cover.
Octagonal boron alloy
shackle.



M115LF



M515LH

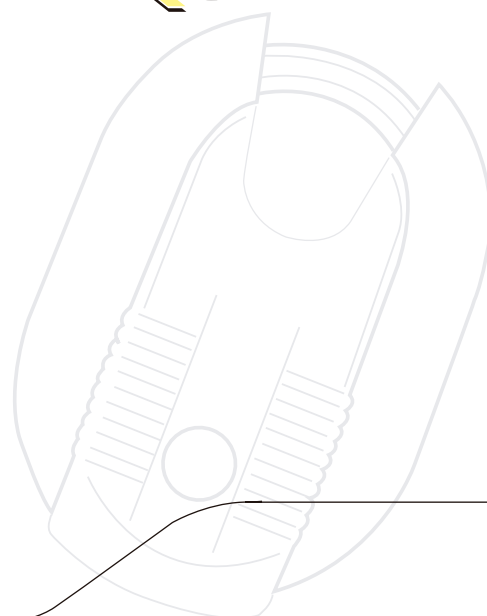

Cadenas en inox renforcé au titane.
Anse protégée octogonale en alliage de bore.

Stainless steel padlock titanium reinforced.
Octagonal boron alloy shrouded shackle.

CADENAS EN INOX / STAINLESS STEEL BODY

Cadenas en inox.
Anse protégée octogonale
en alliage de bore.

Stainless steel body.
Octagonal boron alloy
shrouded shackle.



M40



M50



M187

	Cadenas en acier laminé - protection thermoplastique/Laminated steel padlocks - Thermoplastic cover					Cadenas en inox/Stainless steel padlocks			
Référence/Reference	M115EURDLF	M115EURTLF	M115EURTRILF	M515EURDLH	M515EURTLH	M40EURD	M40EURT	M50EURD	M187EURD
Largeur du corps/Body width	45 mm	45 mm	45 mm	51 mm	51 mm	70 mm	70 mm	80 mm	60 mm
Diamètre de l'anse/Shackle diameter	8 mm	8 mm	8 mm	10 mm	10 mm	10 mm	10 mm	12 mm	8 mm
Hauteur d'anse/Shackle length	38 mm	38 mm	38 mm	51 mm	51 mm	16 mm	16 mm	17 mm	24 mm
Ecartement de l'anse/Horiz. shackle clearance	20 mm	20 mm	20 mm	24 mm	24 mm	21 mm	21 mm	24 mm	22 mm
Corps/Body									
Acier inoxydable/Stainless steel						•	•	•	•
Acier laminé/Laminated steel	•	•	•	•	•				
Protection thermoplastique/Thermoplastic cover	•	•	•	•	•				
Anse/Shackle									
Alliage de bore/Boron alloy	•	•	•	•	•	•	•	•	•
Double verrouillage à billes/Double-ball bearing locking	•	•	•	•	•	•	•	•	•
Cylindre/Cylinder									
Nombre de goupilles/Number of pins	4	4	4	4	4	4	4	4	4
Nombre de clés/Number of keys	4	4	4	4	4	4	4	4	4
Cadenas s'ouvrant/Keyed alike padlocks <i>Une même clé ouvre tous les cadenas/Same key opens all padlocks</i>		•	•		•		•		
Nombre de cadenas/Number of padlocks		2	3		2		2		



Master

BORON - CARBIDE



HAUTE SÉCURITÉ

HIGH SECURITY

Certaines applications, comme la protection d'une unité de stockage, d'un site de production, d'un chantier ou la fermeture d'un rideau de magasin, nécessitent des cadenas de haute sécurité résistant à toutes formes d'agressions. MasterLock® propose une gamme de cadenas répondant à ces exigences. Les cadenas Master Lock® bénéficient d'une **garantie à vie limitée**.

Some applications, such as storage units, manufacturing sites, and shop fronts, need high security padlocks with greater resistance to physical attacks. MasterLock® offers a padlock range that meets all these requirements.

*All MasterLock® padlocks have a **limited lifetime guarantee**.*

Master Lock® n'a de cesse de rechercher et de développer des produits innovants qui allient sécurité et praticité d'utilisation. C'est dans cet esprit que le cadenas à anse HEXagonale a été conçu.

L'innovation ?
Son anse HEXagonale en acier cémenté qui offre une protection accrue contre le coupe-boulon.

Son corps très épais est en laiton massif (il existe en 40, 50 et 60 mm).

Il est aussi disponible en finition nickelée (40 mm) anti-corrosion.

Cadenas à anse HEXagonale, une exclusivité Master Lock®.



Anse HEXagonale en acier cémenté.
Double verrouillage.
Cylindre de sécurité.
Clé réversible.

HEXagonal hardened steel shackle.

*Double locking.
High security cylinder.
Dimple key.*



1145P



1145



1155



1165

Master Lock® is permanently researching and developing innovative products combining security & convenience.

HEXagonal shackle padlocks have been created with this in mind.

*What's innovative?
Its HEXagonal hardened steel shackle brings increased bolt-cutter resistance.*

The extra thick body is brass (available in 40, 50 and 60 mm).

There is also a 40 mm nickel finish anti-rust version.

HEXagonal shackle padlocks, exclusive to Master Lock®.

Cadenas anse HEXagonale/HEXagonal shackle padlocks

Référence/Reference	1145PEURD	1145EURD	1155EURD	1165EURD
Largeur du corps/Body width	40 mm	40 mm	50 mm	60 mm
Diamètre de l'anse/Shackle diameter	7,5 mm	7,5 mm	9 mm	11 mm
Hauteur d'anse/Shackle length	23 mm	23 mm	30 mm	33 mm
Ecartement de l'anse/Horiz. shackle clearance	22 mm	22 mm	28 mm	32 mm
Corps/Body				
Laiton massif/Solid brass		•	•	•
Laiton massif nickelé brossé/Nickel plated solid brass	•			
Anse/Shackle				
Acier cémenté/Hardened steel		•	•	•
Acier finition nickelée/Nickel plated	•			
Double verrouillage/Double locking	•	•	•	•
Cylindre/Cylinder				
Nombre de goupilles/Number of pins	6	6	6	6
Nombre de clés/Number of keys	4	4	4	4

CADENAS BLINDÉS

ARMOURED PADLOCKS



680



680



690



690

Anse protégée en acier cémenté.
Corps zinc avec blindage acier cémenté.
Cylindre à goupilles.
Protection du cylindre.

*Shrouded hardened steel shackle.
Solid armoured zinc body.
Pin tumbler cylinder.
Cylinder protection.*

Cadenas blindés/Armoured padlocks		
Référence/Reference	680EURD	690EURD
Largeur du corps/Body width	80 mm	90 mm
Diamètre de l'anse/Shackle diameter	11 mm	12 mm
Hauteur d'anse/Shackle length	14 mm	17 mm
Ecartement de l'anse/Horiz. shackle clearance	29 mm	36 mm
Corps/Body		
Zinc/Zinc	•	•
Blindage acier cémenté/Armoured	•	•
Anse/Shackle		
Acier cémenté/Hardened steel	•	•
Cylindre/Cylinder		
Nombre de goupilles/Number of pins	5	5
Nombre de clés/Number of keys	4	4

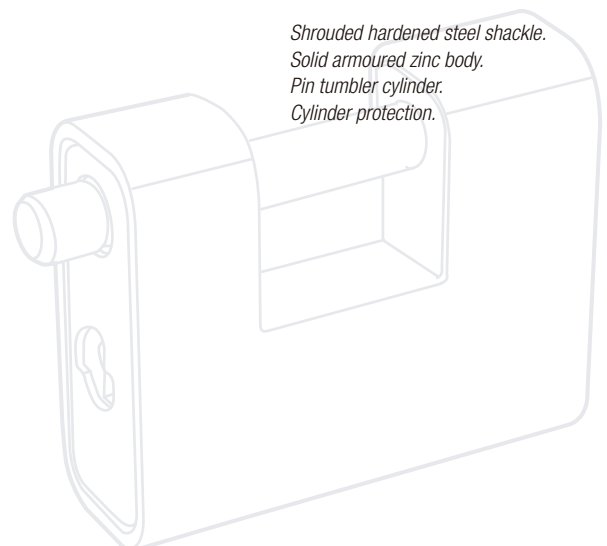

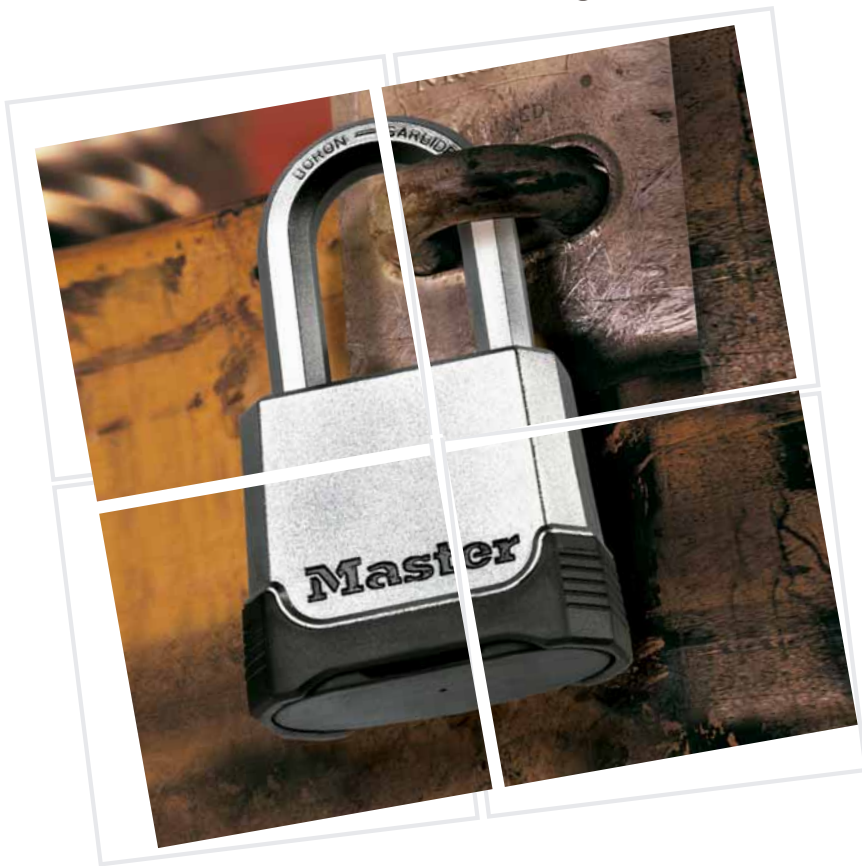

HAUTE SÉCURITÉ HIGH SECURITY

Cadenas à combinaison programmable à 4 chiffres.
Anse en acier cémenté.
Double verrouillage.
Bouton poussoir.

4-digit set-your-own combination.
Hardened steel shackle.
Dual locking.
Push-button.



651

Cadenas à combinaison programmable à 4 chiffres.
Corps en zinc chromé pour résister à la corrosion.
Anse octogonale en alliage de bore.
Capuchon de protection de combinaison.

4-digit set-your-own combination.
Chrome plated zinc die-cast body for corrosion resistance.
Octagonal boron alloy shackle.
Covered dials for superior weather protection.

EXCELL®



M175LF



M175LH

Référence/Reference	Cadenas à combinaison/Combination padlocks			Excell®	
	651EURD	175EURD	175EURDLH	M175EURDLF	M175EURDLH
Largeur du corps/Body width	50 mm	51 mm	51 mm	50 mm	50 mm
Diamètre de l'anse/Shackle diameter	9 mm	8 mm	8 mm	9 mm	9 mm
Hauteur d'anse/Shackle length	32 mm	25 mm	57 mm	38 mm	51 mm
Ecartement de l'anse/Horiz. shackle clearance	24 mm	25 mm	25 mm	24 mm	24 mm
Corps/Body					
Laiton/Brass	•				
Zinc finition laiton/Brass finish zinc		•	•		
Zinc chromé/Chrome plated zinc				•	•
Anse/Shackle					
Acier cémenté/Hardened steel	•	•	•		
Alliage de bore/Boron alloy				•	•
Double verrouillage/Double Locking	•	•	•	•	•
Combinaison/Combination					
4 chiffres programmables/4-resettable digits	•	•	•	•	•



175

Cadenas à combinaison programmable à 4 chiffres.
Entrez votre propre combinaison à l'aide d'une clé de codage
10 000 combinaisons possibles.

Set-your-own combination padlock.
Enter your personal 4 digit combination by using the reset key.
10 000 possible combinations.

CADENAS ACIER LAMINÉ

LAMINATED STEEL PADLOCKS

CADENAS ACIER LAMINÉ

LAMINATED STEEL PADLOCKS

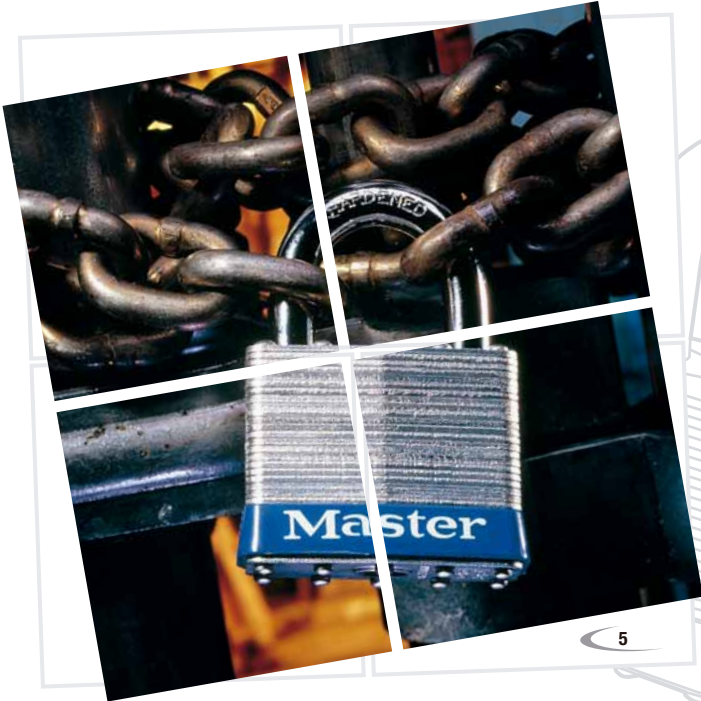

Cadenas acier laminé.
Anse en acier cémenté.
Double verrouillage.

*Laminated steel padlock.
Hardened steel shackle.
Double locking.*



Les cadenas en acier offrent une parfaite résistance au martelage, aux chocs et tentatives de vol.

Les cadenas en acier laminé Master Lock® sont disponibles avec des cylindres fixes ou amovibles à 4, 5 ou 6 goupilles.

Pour des applications nécessitant une sécurité maximum, ils sont disponibles en 50 et 65 mm (pour des applications plus générales, se reporter à la page 11 du catalogue).

Le cadenas en acier massif a une anse en alliage de bore entièrement protégée par le corps du cadenas pour une résistance totale contre la coupe et l'arrachage.

Steel padlocks offer a strong resistance to hammering, shock and physical abuse for dependable protection against theft.

Master Lock®'s laminated steel padlocks are available with fixed or removable 4, 5 or 6 pin cylinders. For maximum security, they are available in 50 and 65 mm (for more general application, see page 11 of this catalogue).

Solid steel padlock design fully shrouds and protects the boron alloy shackle to defeat attempts to pry and cut.

CADENAS ACIER MASSIF ANSE PROTÉGÉE

HIDDEN SHACKLE SOLID STEEL PADLOCK



Corps acier massif.
Anse protégée en alliage de bore par le corps du cadenas.
Cylindre à 6 goupilles.

*Solid steel body.
Padlock design fully shrouds and protects the boron alloy shackle.
6-pin tumbler cylinder.*

6270

Cadenas/Padlocks	Acier laminé Laminated steel		Acier massif Solid steel
	5EURD	15EURD	6270
Référence/Reference			
Largeur du corps/Body width	51 mm	64 mm	73 mm
Diamètre de l'anse/Shackle diameter	10 mm	11 mm	10 mm
Hauteur d'anse/Shackle length	25 mm	32mm	-
Ecartement de l'anse/Horiz. shackle clearance	24 mm	30 mm	-
Corps/Body			
Acier laminé/Laminated steel	•	•	
Acier massif/Solid steel			•
Anse/Shackle			
Acier cémenté/Hardened steel	•	•	
Alliage de bore/Boron alloy			•
Double verrouillage/Double locking	•	•	•
Cylindre/Cylinder			
Nombre de goupilles/Number of pins	4	5	6
Nombre de clés /Number of keys	2	2	2

Master Lock® Excell® est la première gamme de cadenas haute sécurité qui s'adaptent à tous les supports, à toutes les configurations d'usage et à toutes les conditions climatiques.

Au total, 40 brevets ont été déposés pour protéger les innovations développées par MasterLock®. L'ensemble des cadenas de la gamme présente ainsi de solides arguments qui garantissent une sécurité maximale en toutes circonstances :

- anse octogonale en alliage de bore, deux fois plus résistante à la coupe qu'une anse classique,
- double verrouillage à billes, deux fois plus résistant à la traction et à l'effet de levier,
 - capuchon de protection du cylindre ou de la combinaison pour une meilleure résistance aux intempéries et à la poussière,
 - bumper (pare-chocs) en caoutchouc pour protéger les surfaces des éraflures.

Grace à la multiplicité des formats proposés, aux caractéristiques spécifiques et au design innovant de chaque modèle, Excell® répond à toutes les exigences en matière de haute sécurité et ce, quelles que soient les applications, professionnelles ou grand public.

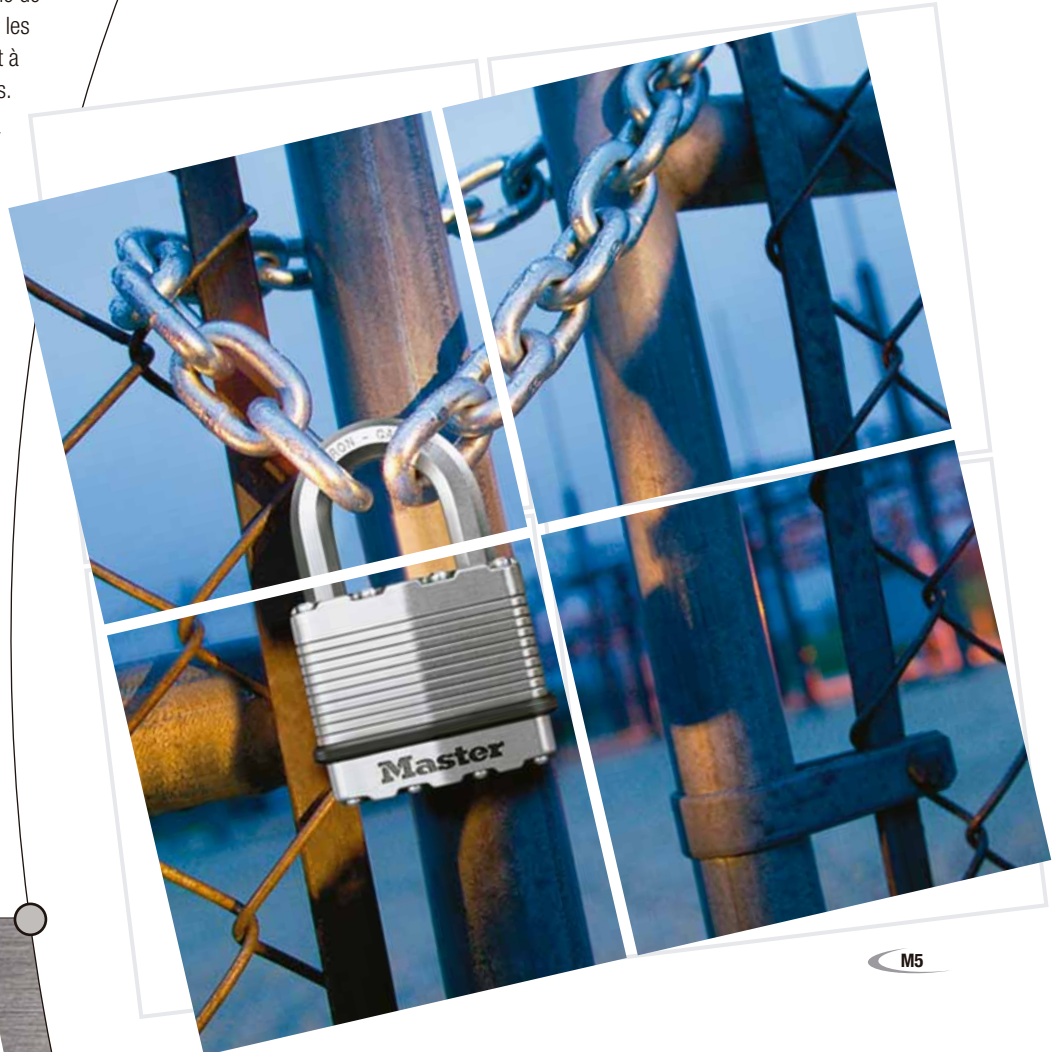

M5

Master Lock® Excell® is the first range of padlocks to offer maximum security and strength combined with versatility and weather resistance.

Altogether, 40 patents have been filed to protect the innovations developed by Master Lock®.

- All the locks have common components that help deliver maximum security including;*
- *Octagonal boron-carbide shackles, which are twice as resistant to cutting as standard shackles.*
 - *Dual ball bearing locking that gives twice the pull strength and pry resistance.*
 - *A protective cap on the cylinder or combination for better protection against the elements.*
 - *Rubber bumpers to protect surfaces from scratches.*

Whatever the application, professional or consumer, Excell® delivers with innovative design, maximum security and the widest range of features available.

Cadenas Excell® en acier laminé/Excell® laminated steel padlocks

Référence/Reference	M1EURT	M1EURTRI
Largeur du corps/Body width	45 mm	45 mm
Diamètre de l'anse/Shackle diameter	8 mm	8 mm
Hauteur d'anse/Shackle length	24 mm	24 mm
Ecartement de l'anse/Horiz. shackle clearance	20 mm	20 mm
Corps/Body		
Acier laminé/Laminated steel	•	•
Protection extérieure inox & zinc/Stainless steel & zinc sleeve	•	•
Anse/Shackle		
Alliage de bore/Boron alloy	•	•
Double verrouillage à billes/Dual ball bearing locking	•	•
Cylindre/Cylinder		
Nombre de goupilles/Number of pins	4	4
Nombre de clés/Number of keys	4	4
Cadenas s'ouvrant/Keyed alike padlocks		
<i>Une même clé ouvre tous les cadenas/Same key opens all padlocks</i>		
Nombre de cadenas/Number of padlocks	2	3

EXCELL®



Corps en acier laminé.
Protection extérieure en inox et zinc pour résister aux intempéries.
Anse octogonale en alliage de bore.
Double verrouillage à billes.
4 clés.

*Laminated steel case.
Stainless steel and zinc cover sleeve for weather resistance.
Octagonal Boron-Carbide shackle.
Dual ball bearing locking.
4 keys.*



M1



M1LJ



M5



M15LF

M1EURDLF	M1EURDLH	M1EURTRILH	M1EURDLJ	M5EURD	M5EURT	M5EURDLF	M5EURTLF	M5EURTRILF	M5EURDLH	M5EURDLJ	M15EURDLF	M15EURTLF
45 mm	45 mm	45 mm	45 mm	50 mm	50 mm	50 mm	50 mm	50 mm	50 mm	50 mm	64 mm	64 mm
8 mm	8 mm	8 mm	8 mm	9 mm	9 mm	9 mm	9 mm	9 mm	9 mm	9 mm	11 mm	11 mm
38 mm	51 mm	51 mm	64 mm	25 mm	25 mm	38 mm	38 mm	38 mm	51 mm	64 mm	38 mm	38 mm
20 mm	20 mm	20 mm	20 mm	24 mm	24 mm	24 mm	24 mm	24 mm	24 mm	24 mm	36 mm	36 mm
•	•	•	•	•	•	•	•	•	•	•	•	•
•	•	•	•	•	•	•	•	•	•	•	•	•
•	•	•	•	•	•	•	•	•	•	•	•	•
•	•	•	•	•	•	•	•	•	•	•	•	•
4	4	4	4	4	4	4	4	4	4	4	5	5
4	4	4	4	4	4	4	4	4	4	4	4	4
		•			•		•		•			•
		3			2		2		3			2



M5B

Cadenas en acier laminé.
Protection extérieure en zinc avec finition
laiton pour résister à la corrosion.
Anse octogonale en alliage de bore
brevetée.

*Laminated steel case.
Zinc cover sleeve with brass finish
for weather resistance.
Patented boron-carbide octagonal shackle.*

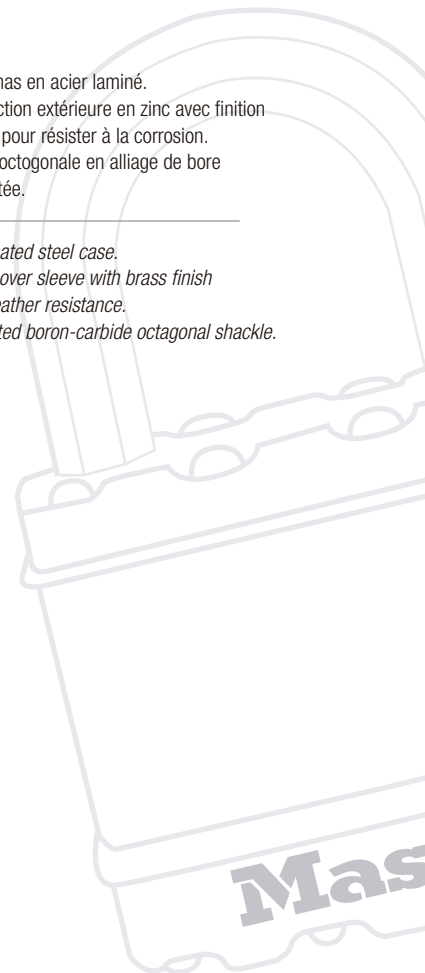

ACIER MASSIF SOLID STEEL



Corps en acier massif ou zinc chromé pour résister à la corrosion.
Anse octogonale en alliage de bore.
Double verrouillage à billes.
4 clés.

*Chrome-plated solid steel or zinc die cast body for corrosion resistance.
Octagonal Boron-carbide shackle.
Dual ball bearing locking.
4 keys.*

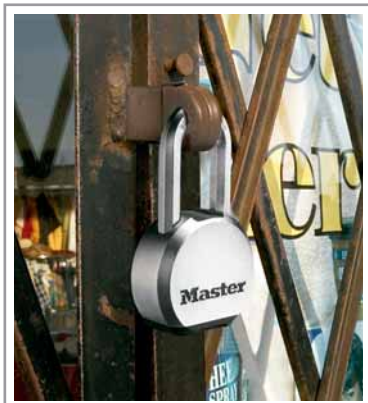

M930LH

Cadenas Excell® en acier massif/Excell® solid steel padlocks		
Référence/Reference	M830EURDLH	M930EURDLH
Largueur du corps/Body width	54 mm	64 mm
Diamètre de l'anse/Shackle diameter	10 mm	11 mm
Hauteur d'anse/Shackle length	51 mm	51 mm
Ecartement de l'anse/ Horiz. shackle clearance	20 mm	23 mm
Corps/Body		
Zinc chromé/Chrome-plated zinc die cast	•	
Acier massif/Solid steel		•
Anse/Shackle		
Alliage de bore/Boron alloy	•	•
Double verrouillage à billes/Dual ball bearing locking	•	•
Cylindre/Cylinder		
Nombre de goupilles/Number of pins	4	5
Nombre de clés/Number of keys	4	4



M830LH

M930LH

Double verrouillage à billes.
4 clés fournies.

Dual ball bearing locking.
Available with 4 keys.

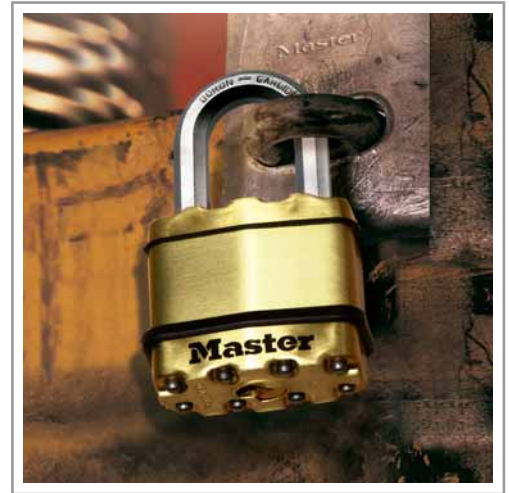

M15BLF



M1B



M1BLF



M5BLH



M15BLF

Cadenas Excell® finition laiton/Brass finish Excell® padlocks

Référence/Reference	M1BEURD	M1BEURT	M1BEURDLF	M5BEURD	M5BEURTRI	M5BEURTFL	M5BEURDLH	M5BEURDLJ	M15BEURDLF
Largeur du corps/Body width	45 mm	45 mm	45 mm	50 mm	50 mm	50 mm	50 mm	50 mm	64 mm
Diamètre de l'anse/Shackle diameter	8 mm	8 mm	8 mm	9 mm	9 mm	9 mm	9 mm	9 mm	11 mm
Hauteur d'anse/Shackle length	24 mm	24 mm	38 mm	25 mm	25 mm	38 mm	51 mm	64 mm	38 mm
Ecartement de l'anse/Horiz. shackle clearance	20 mm	20 mm	20 mm	24 mm	24 mm	24 mm	24 mm	24 mm	36 mm
Corps/Body									
Acier laminé/Laminated steel	•	•	•	•	•	•	•	•	•
Protection extérieure laiton & zinc/Brass & zinc sleeve	•	•	•	•	•	•	•	•	•
Anse/Shackle									
Alliage de bore/Boron alloy	•	•	•	•	•	•	•	•	•
Double verrouillage à billes/Dual ball bearing locking	•	•	•	•	•	•	•	•	•
Cylindre/Cylinder									
Nombre de goupilles/Number of pins	4	4	4	4	4	4	4	4	5
Nombre de clés/Number of keys	4	4	4	4	4	4	4	4	4
Cadenas s'ouvrant/Keyed alike padlocks									
Une même clé ouvre tous les cadenas/Same key opens all padlocks		•			•	•			
Nombre de cadenas/Number of padlocks		2			3	2			

Master Lock® a mené une étude pendant 2 ans afin de comprendre les attentes de ses clients en matière de cadenas haute sécurité.

L'étude démontre un réel besoin pour des cadenas :

- de très haute sécurité avec résistance optimale à toutes les formes d'agressions,
- avec une fiabilité à toute épreuve quelles que soient les conditions climatiques.

Les cadenas Pro Series™ de Master Lock® répondent à toutes ces attentes.

Les cadenas Pro Series™ sont proposés avec anse protégée ou joint d'étanchéité avec protection de serrure et canaux d'écoulement.

Les Pro Series™ offrent une véritable différence en terme de sécurité, de fiabilité et de facilité d'utilisation.



6327

Over 2 years, Master Lock® listened to what its industrial, commercial and retail customers wanted in a heavy duty padlock. It revealed a major need for padlocks that offer :

- *high security with greater resistance against physical attacks*
- *reliable performance in harsh environments.*

The Master Lock® Pro Series™ padlocks meet all these requirements. The Pro Series™ are made either with weather tough or high security shrouded features.

Pro Series™ offer you a real difference in security, dependability and convenience.

Anse en alliage de bore. Haute résistance au sciage et au coupe-boulons.

Hardened boron alloy shackle. Heavy protection against cutting and sawing.

Revêtement thermoplastique Xenoy®. Résiste aux agressions et températures extrêmes.

Xenoy® thermoplastic cover. Withstands attacks and extreme temperatures.

Joint d'étanchéité en estane.

Estane shackle seals.

Double verrouillage à billes. Résiste à la barre de torsion et au martelage.

Dual ball bearing locking. Protection against prying and hammering.

Cylindre haute sécurité à 6 goupilles. Haute résistance au crochetage.

High security cylinder with 6 spool pins. Provides high resistance to picking.

Corps en acier laminé renforcé.

High security laminated steel body.

Protection de serrure. Canaux d'écoulement

Snap on cap. Flow through debris channels.

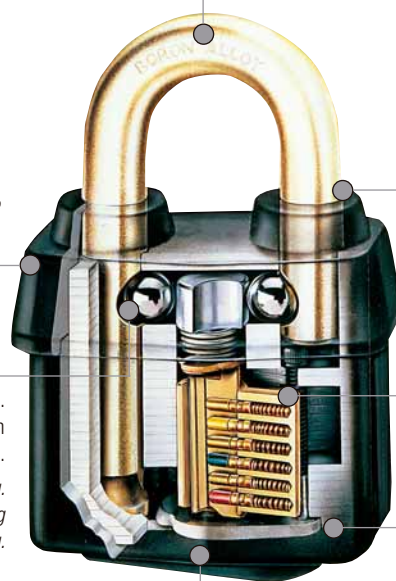

TOUTES INTEMPÉRIES
WEATHER TOUGH



ANSE PROTÉGÉE
SHROUDED SHACKLE



6321



6327



6121J



6127



6327



6127

Anse protégée.
Revêtement thermoplastique Xenoy®.
Anse en alliage de bore.
Double verrouillage à pêne dormant.

Shrouded shackle.
Xenoy® thermoplastic cover.
Boron alloy shackle.
Dual ball bearing locking.
Deadbolt locking.

Joint d'étanchéité en estane.
Protection de serrure.
Canaux d'écoulement.
Revêtement thermoplastique Xenoy®.
Double verrouillage à billes.

Estane shackle seals.
Snap on cap.
Flow through channels.
Xenoy® thermoplastic cover.
Dual ball bearing locking.



6327

ProSeries™ Anse protégée/Shrouded shackle	Toutes intempéries/Weather Tough®			
Référence/Reference	6321EURD	6327EURD	6121EURDLJ	6127EURD
Largueur du corps/Body width	54 mm	67 mm	54 mm	67 mm
Diamètre de l'anse/Shackle diameter	8 mm	11 mm	8 mm	11 mm
Hauteur d'anse/Shackle length	20 mm	20 mm	61 mm	35 mm
Ecartement de l'anse/Horiz. shackle clearance	23 mm	23 mm	23 mm	23 mm
Corps/Body				
Acier laminé/Laminated steel	•	•	•	•
Protection Xenoy/Xenoy cover	•	•	•	•
Anse/Shackle				
Alliage acier-bore/Boron alloy	•	•	•	•
Double verrouillage à billes/Dual ball bearing locking	•	•	•	•
À pêne dormant/Deadbolt locking	•	•	•	•
Cylindre/Cylinder				
Nombre de goupilles/Number of pins	6	6	6	6
Nombre de clés/Number of keys	2	2	2	2



PORTE-CADENAS

HASPS

Une porte sans verrou ? Les morillons permettent de sécuriser des placards, caves ou tout autre local de rangement.

Afin d'aider le consommateur dans son choix, cette gamme est divisée en 3 principaux usages :

- utilisations intérieures, pour verrouiller l'accès à des boîtes à outils, placards ou caves,
- utilisations extérieures, pour sécuriser abris de jardin, barrières ou portails,
- utilisations spécifiques, une sécurité supplémentaire à des portes de camions, rideaux de magasins ou portes d'usine.

No lock on a door? Then hasps will help secure cupboards, doors, cellars, sheds and many other storage places.

To help ensure customers make the right choice, Master Lock®'s range of hasps has been structured around 3 main uses:

- *Indoor use to lock tool boxes, cupboards and storage units*
- *Outdoor use for sheds and gates*
- *Tailored use for van doors, shop fronts and outdoor security fences.*

Plus connus sous l'appellation « porte-cadenas », Master Lock® propose des morillons en complément de son offre de cadenas.

Différents types de produits sont disponibles selon les besoins :

- les œillets,
- les morillons tout usage,
- les morillons avec charnière,
- les morillons haute sécurité,
- les morillons avec verrouillage intégré.

Les morillons Master Lock® sont disponibles à l'unité ou en lot morillon-cadenas, solution complète et prête à l'emploi.

La gamme porte-cadenas offre ainsi une solution à toutes situations, grâce à des produits différents et uniques.

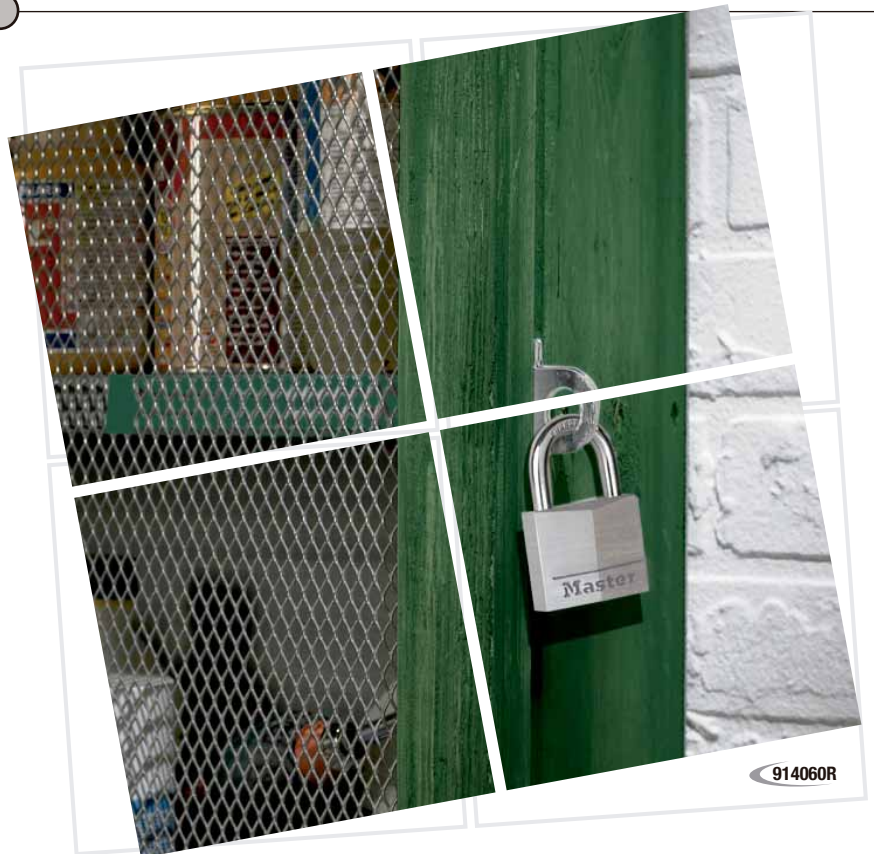

LOTS ŒILLETS AVEC CADENAS PADLOCK EYES SET WITH PADLOCK

In addition to the padlock range, Master Lock® provides a selection of hasps.

Different types of products are available according to needs:

- padlocks eyes,
- general use hasps,
- hasps with hinges,
- high security hasps,
- or hasps with integrated locking system.

Master Lock® hasps are available as individual products or in pack with a padlock offering a complete and 'ready to be used' solution.

The hasp range offers a solution too many needs through unique and tailored products.



914060

Œillets plats 60 Flat padlock eyes 60
Cadenas aluminium 9140 Aluminium padlock 9140



914060R

Œillets à angle droit 60R Right angle padlock eyes 60R
Cadenas aluminium 9140 Aluminium padlock 9140

PORTE-CADENAS AVEC SERRURE INTÉGRÉE HASP WITH INTEGRATED LOCK



705



705



Fixation en aveugle Hidden hinge pins



Moraillon 703 Hasp 703
Cadenas laiton 140 Brass padlock 140



Moraillon 703 Hasp 703
Cadenas à combinaison programmable 7630 Resettable combination padlock 7630



9140703BLK
Moraillon 703 Hasp 703
Cadenas couverture vinyl cover padlock
vinyle 9140BLK 9140BLK



Moraillon 703 Hasp 703
Cadenas aluminium 9140 Aluminium padlock 9140

FERMOIR PORTE-CADENAS TOGGLE LATCH HASP



446

Fermeoir acier
Cadenas à combinaison programmable 7630

Steel toggle latch
Resettable combination padlock 7630



446

Porte-cadenas/Hasps	914060EURD	914060REURD	702EURD	702EURDWB	703EURD	703EURDB	703EURDWB	705EURD	446EURD
Référence/Reference									
Longueur du corps/Hasp length	-	-	64 mm	64 mm	89 mm	89 mm	89 mm	80 mm	90 mm
Accepte anse Ø jusqu'à/Accepts shackle Ø up to	13 mm	13 mm	7 mm	7 mm	9 mm	9 mm	9 mm	-	5 mm
Corps/Body									
Acier trempé/Hard wrought steel	•	•	•	•	•	•	•		•
Acier traité/Treated steel								•	
Fixation en aveugle/Hidden hinge pins	•		•	•	•	•	•	•	
Serrure intégrée/Built-in lock								•	
Finition/Finish					Blanc&Noir White&Black	Doré poli Polish gold	Blanc&Noir White&Black		Blanc&Noir White&Black
Cadenas/Padlock	9140EURD	9140EURD							7630EURD



704BLK



704



706

Fixation en aveugle Hidden hinge pins



7804704

Morillon 704 Hasp 704
Cadenas acier laminé avec
protection toutes intempéries Laminated steel padlock
with weathertough cover



7640704

Morillon 704 Hasp 704
Cadenas à combinaison
programmable 7640 Resettable combination
padlock 7640



9150704BLK

Morillon 704 Hasp 704
Cadenas couverture vinyle
9150BLK Vinyl cover padlock
9150BLK

PORTE-CADENAS À CHARNIÈRE POUR VERROUILLAGE D'ANGLE ANGLE LOCKING HASPS WITH HINGES

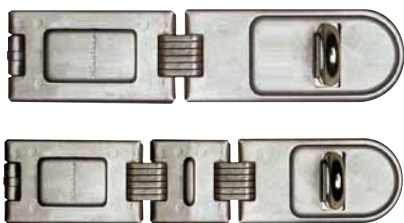

721

722

Fixation en aveugle Hidden hinge pins



606720

Morillon 720 Hasp 720
Cadenas laiton
rectangulaire 606 Rectangular brass
padlock 606



606720

PORTE-CADENAS AVEC VERROUILLAGE INTÉGRÉ HASPS WITH INTEGRATED LOCKING SYSTEM



725

Morillon acier avec serrure intégrée
Steel hasp with integrated lock



471

Morillon acier cémenté.
Cadenas en acier laminé avec protection
thermoplastique et capuchon protecteur.
Hardened steel hasp.
Laminated steel integrated padlock with
thermoplastic cover and lock cap.



471

VERROU PORTE-CADENAS BOLT HASP



448



448

Verrou acier plaqué chrome
Cadenas acier inoxydable
Chrome plated steel bolt
Stainless steel padlock

PORTE-CADENAS FONTE NOIRE HAUTE SÉCURITÉ HIGH SECURITY CAST STEEL HASP



724

Fixation en aveugle Hidden hinge pins



1145723P

Morillon 723 Hasp 723
Cadenas laiton nickelé 1145P Nickel plated brass padlock 1145P



723

Porte-cadenas/Hasps

Référence/Reference	704EURD	704EURDBLK	706EURD	720EURD	721EURD	722EURD	723EURD	724EURD	725EURD	471EURD	448EURD
Longueur du corps/Hasp length	115 mm	115 mm	152 mm	160 mm	200 mm	200 mm	140 mm	180 mm	117 mm	110 mm	120 mm
Accepte anse Ø jusqu'à/Accepts shackle Ø up to	13 mm	13 mm	14 mm	11 mm	13 mm	12 mm	11 mm	14,6 mm	-	-	11 mm
Corps/Body											
Acier cémenté/Hardened steel	•	•	•	•	•	•				•	
Acier chromé/Chrome plated steel											•
Fonle noire/Cast steel							•	•			
Traitement antirouille/Anti-rust finish				•	•	•			•		•
CEillet en alliage de bore/Boron eyes				•	•	•	•	•			
Fixation en aveugle/Hidden hinge pins	•	•	•	•	•	•	•	•	•	•	
Simple charnière/Single hinge				•	•						
Double charnière/Double hinge						•					
Serrure intégrée/Built-in lock									•	•	
Finition/Finish		Noir/Black					Noir/Black	Noir/Black			



736



731

Morillon pour portes adjacentes.
Hasp for adjacent doors.



780

Morillon pour grilles, rideaux de magasin, portails...
Hasp for gate, store front gates...



736

Morillon 770 Hasp 770
Cadenas zinc nickelé Nickel zinc padlock



770

Morillon haute sécurité pour portes de camion, containers...
High security hasp for truck doors, containers...

















780

Porte-cadenas/Hasps				
Référence/Reference	731EURD	770	780EURD	
Longueur du corps/Hasp length	190 mm	230 mm	135 mm	
Accepte anse Ø jusqu'à/Accepts shackle Ø up to	11 mm	-	13 mm	
Corps/Body				
Acier cémenté/Hardened steel	•	•	•	
Traitement antirouille/Anti-rust finish	•	•	•	

ÉBAUCHES DE CLÉS

KEY BLANKS

	Référence ébauche <i>Key blank number</i>	Référence cadenas <i>Padlock number</i>	Quantité par boîte <i>Quantité per box</i>
	K1BOX K7BOX K15BOX	Acier laminé/Laminated steel N° 1, 3, 5, 311, 312, 313, 317, 40 N° 7, 90 N° 15	50 50 50
	115KB K120BOX K130BOX K150BOX K170BOX K1950BOX K2240BOX K2250BOX K2930BOX K2940BOX K2950BOX	Laiton massif/Solid brass N° 115, 3115 N° 120, 629, 9120 N° 130, 140, 635, 645, 639, 9130, 9140 N° 150, 160, 606, 607, 608, 655, 640, 9150 N° 170 N° 1950 N° 2240 N° 2250 N° 2930 N° 2940 N° 2950, 2960, 1145, 1145P, 1155, 1165	100 50 50 50 50 50 50 50 50 50 50
	121KB 130KCV-BX-BLKS 150KCV-BX-BLKS 8080KCV-BX-BLKS	Aluminium-protection vinyle/Aluminium-vinyl cover N° 9120BLK, 9120COL, 9121COL N° 9130BLK, 9140BLK, 9131COL, 9141COL N° 9150BLK N° 8080	50 25 25 25
	K4630BOX K192BOX K195BOX	FUSION™ N° 4630 N° 192 N° 195	24 25 25
	K2076BOX	SPHERO® N° 2076	24
	550KCV-BX-BLKS	Marine N° 550	25
	K185BOX	TITANIUM™ N° 189	25
	KM1BOX KM15BOX	Excell® N° M1, M5, M115, M515, M830, M40, M50, M187, M1B, M5B N° M15, M930, M15B	25 25
	K510BOX	Cadenas bouterollés/Warded padlocks N° 510, 517	50
	K175BAG	Cadenas à combinaison/Combination lock N° 175	10
	K900BOX	Cadenas acier massif/Steel padlocks N° 736	50
	K7000BOX	ProSeries™ N° 6127, 6321, 6327, 6270	50
	K680BOX	Cadenas blindés/Armoured padlocks N° 680, 690	25
	K725BOX	Morillon à serrure intégrée/Hasp with integrated lock N° 725	25

CROSS MERCHANDISING SECONDARY PLACEMENT



Présentoir carton 9 broches.
Crochets de fixation.

*9-hook carton display.
Peg hooks included.*

DSPL-SIDE



Présentoir métal 4 broches.
Crochets de fixation.

*4-hook metal display.
Peg hooks included.*

SP-4H



PRÉSENTOIRS DE SOL FLOOR DISPLAYS

Modèle 36 pièces.
Existe aussi en 72 pièces :
Réf : PRES 72.

*Merchandise 36 products.
Also exists in 72 pieces display :
Ref : PRES 72.*

PRES36



6 broches - réf : 1200-0652
6 hooks - ref : 1200-0652

Existe aussi en :
9 broches - réf : 1200-0654

Available in :
9 hooks - ref : 1200-0654

1200-0652

PRÉSENTOIRS DE COMPTOIR COUNTER DISPLAYS

KIT MERCHANDISING
MERCHANDISING KIT



Référence Item Number	Largeur du corps Body width	Page
Cadenas laiton/Brass padlocks		
Anse acier/Steel shackle		
120	20 mm	7
130	30 mm	7
140	40 mm	7
150	50 mm	7
160	60 mm	7
170	70 mm	7
2930	30 mm	8
2940	40 mm	8
2950	50 mm	8
2960	60 mm	8
Anse laiton/Brass shackle		
115	15 mm	9
3115	15 mm	9
635	35 mm	9
645	45 mm	9
655	55 mm	9
Anse protégée/Shrouded shackle		
2240	40 mm	9
2250	50 mm	9
Rectangulaire/Rectangular		
606	63 mm	9
607	76 mm	9
608	85 mm	9
Anse amovible/Removable shackle		
517	45 mm	10
1950	50 mm	10
8080	80 mm	10
Cadenas acier laminé/Laminated steel padlocks		
3	40 mm	11
1	45 mm	11
5	50 mm	45
15	65 mm	45
Cadenas aluminium/Aluminium padlocks		
9120	20 mm	13
9130	30 mm	13
9140	40 mm	13
9150	50 mm	13
Protection vinyle noire/Black vinyl cover		
9120BLK	20 mm	15
9130BLK	30 mm	15
9140BLK	40 mm	15
9150BLK	50 mm	15
Protection vinyle couleur/Colour vinyl cover		
9123COL	20 mm	17
9120COL	20 mm	17
9121COL	20 mm	17
9131COL	30 mm	17
9141COL	40 mm	17
9130PSP	30 mm	17
3430SPO	32 mm	17

Référence Item Number	Largeur du corps Body width	Page
Fusion™		
4630	20 mm	19
195	20 mm	19
192	44 mm	19
Cadenas certifiés TSA/TSA-accepted padlocks		
4680	30 mm	21
4681	32 mm	21
4686	35 mm	21
4688	30 mm	21
Cadenas à combinaison/Combination padlocks		
620	20 mm	23
630	30 mm	23
621BLK	20 mm	23
646	20 mm	23
647	30 mm	23
7620	20 mm	23
7620WHI	20 mm	23
7620COL	20 mm	23
7630	30 mm	23
7630COL	30 mm	23
633	32 mm	24
4684	30 mm	25
4684COL	30 mm	25
4670COL	44 mm	25
4671COL	42 mm	25
632PAT	30 mm	25
1509LOV	30 mm	25
604	40 mm	26
7640	40 mm	26
7640BLK	40 mm	26
1520	64 mm	26
1523	64 mm	26
1524	64 mm	26
1534	64 mm	26
1535COL	37 mm	27
1535GRY	37 mm	27
652	34 mm	27
653	50 mm	27
654	41 mm	27
4603	51 mm	27
One®		
1500iDBLK	55 mm	28
1500iDwhi	55 mm	28
Cadenas à combinaison coffre-fort/Safety box combination padlocks		
1503	48 mm	29
1530	48 mm	29
1533	38 mm	29
1590COL	49 mm	29
Mousquetons/Carabiners		
4673	52 mm	30
603	76 mm	30
1270BOWL	76 mm	30
1270DIS	76 mm	30
1547COL	84 mm	31
1549COL	63 mm	31
1551COL	60 mm	31
1559COL	60 mm	31
1550COL	84 mm	31
1555COL	78 mm	31

Référence Item Number	Largeur du corps Body width	Page
Titanium™		
189	49 mm	34
Couverture thermoplastique/Thermoplastic cover		
312	40 mm	35
317	40 mm	35
Cadenas marine/Marine padlocks		
629	20 mm	37
639	30 mm	37
640	40 mm	37
550	50 mm	37
2340	40 mm	37
40	70 mm	36
Excell® toutes intempéries/Excell® Weather tough®		
M115	45 mm	39
M515	50 mm	39
M40	70 mm	39
M50	80 mm	39
M187	60 mm	39
Cadenas anse Hexagonale/Hexagonal shackle padlocks		
1145P	40 mm	42
1145	40 mm	42
1155	50 mm	42
1165	60 mm	42
Cadenas blindés/Armoured padlocks		
680	80 mm	43
690	90 mm	43
Cadenas combinaison haute sécurité/High security combination padlocks		
175	51 mm	44
651	50 mm	44
M175	50 mm	44
Cadenas acier massif/Solid steel padlock		
6270	73 mm	45
Excell® acier laminé/Excell® laminated steel		
M1	45 mm	47
M5	50 mm	47
M15	64 mm	47
Excell® acier massif/Excell® solid steel		
M830	54 mm	48
M930	64 mm	48
Excell® finition laiton/Excell® brass finish		
M1B	45 mm	49
M5B	50 mm	49
M15B	64 mm	49

Référence Item Number	Largeur du corps Body width	Page
ProSeries™/ProSeries™		
6321	54 mm	51
6121	54 mm	51
6327	67 mm	51
6127	67 mm	51
Porte-cadenas utilisations intérieures/Indoor use hasps		
914060	40 mm	55
914060R	40 mm	55
702	64 mm	55
703	89 mm	55
705	80 mm	55
446	90 mm	55
Porte-cadenas utilisations extérieures/Outdoor use hasps		
704	115 mm	57
706	152 mm	57
720	160 mm	57
721	200 mm	57
722	200 mm	57
723	140 mm	57
724	180 mm	57
725	117 mm	57
471	110 mm	57
448	120 mm	57
Porte-cadenas utilisations spécifiques/Specific use hasps		
731	190 mm	58
770	230 mm	58
780	135 mm	58
Ébauches de clés/Key blanks		59
Merchandising		60

Master Lock®

MASTER LOCK EUROPE S.A.S
131, AVENUE CHARLES DE GAULLE
92200 NEUILLY-SUR-SEINE - FRANCE
TEL. : +33 (0)1.41.43.72.00
FAX : +33 (0)1.41.43.72.01
E-MAIL : MLE@MASTER-LOCK.FR
WWW.MASTERLOCK.EU

©2016